

SUPERCHAIR

Contraddistinta da una silhouette unica, Super Chair è una sedia monoblocco, impilabile, in plastica riciclata al 100%, dalle forme organiche e armoniose destinata agli ambienti domestici e al contract. Super Chair è un progetto nato con l'ambizione di realizzare una sedia che possa diventare un'icona nel mondo delle sedute, riconoscibile per la sua forma e per l'effetto vellutato del materiale. La sedia, interamente Made in Italy, è stata prodotta con tecnologia di stampaggio ad iniezione, in polipropilene riciclato al 100% con finitura SILKY® per una resa più sofisticata e per donare alla sedia un effetto vellutato.

Distinguished by a unique silhouette and organic and harmonious shapes, Super Chair is a stackable monobloc 100% recycled plastic chair, intended for domestic and contract environments. Super Chair is a project conceived with the ambition of becoming an icon in the seating world, easily recognizable from the shape and the soft touch effect. The chair, entirely Made in Italy, is produced with injection molding technology and it's made of 100% recycled polypropylene with a SILKY® finish to give the chair a more sophisticated rendering and a velvety soft touch.

Design

Nicholas Baker

Art Direction

Antonio Lanzillo

& Partners

Informazioni tecniche

p. 38











SUPERCHAIR

Design Nicholas Baker

Art direction Antonio Lanzillo & Partners





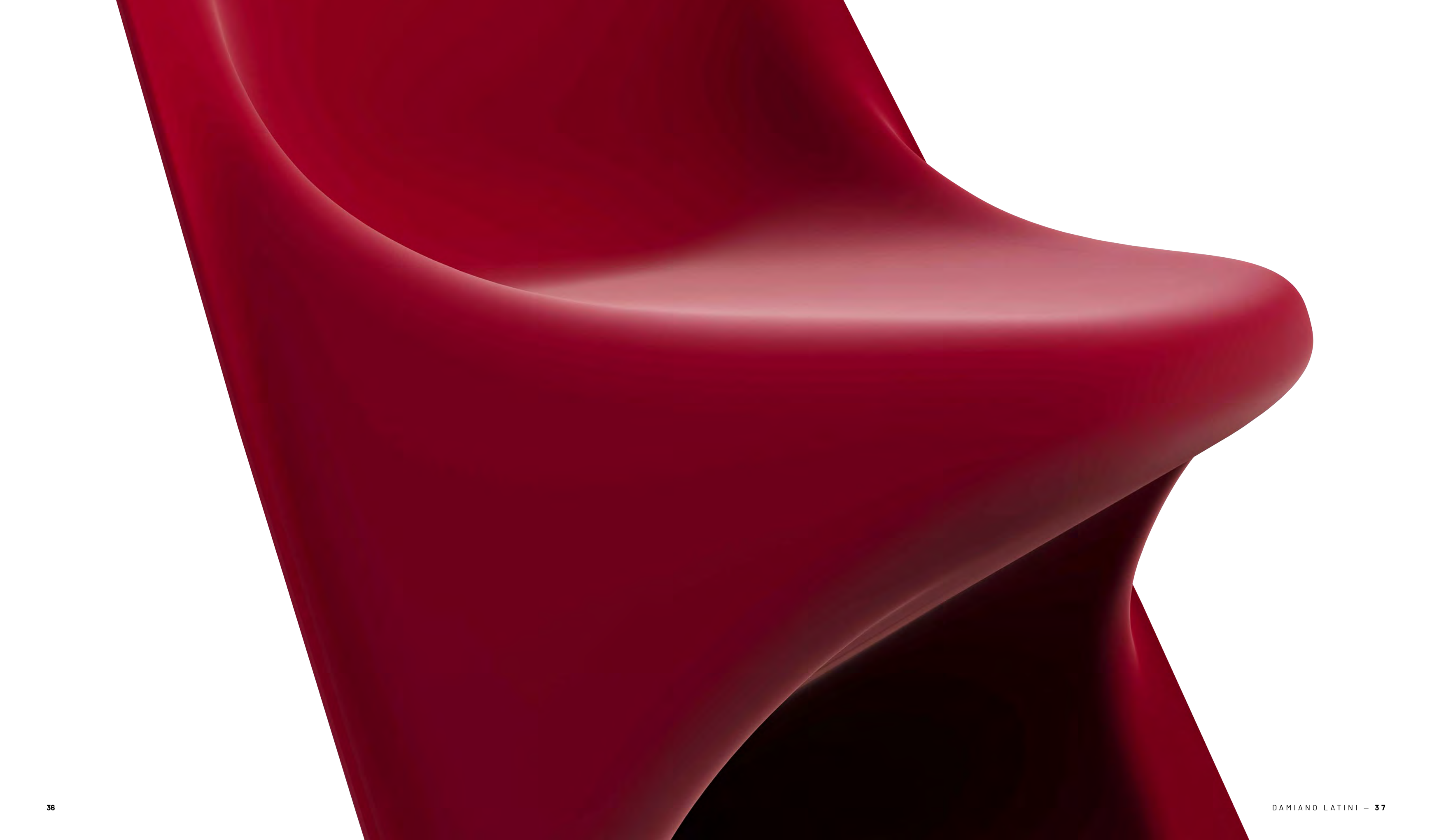



SUPERCHAIR

Polipropilene 100% riciclato / 100% recycled polypropylene



Il designer, Nicholas Baker, per ottenere questa silhouette unica, ha sviluppato il concept partendo da un piano rettangolare che ha modellato con l'aiuto di un visore VR e software dedicato fino a ricavarne una forma sinuosa e fluida, immediatamente riconoscibile. Super Chair è stampata ad iniezione in polipropilene riciclato con tecnologia RE-LIFE® in cui la parte polimerica è ottenuta dal riciclo di sfrido e scarto industriale senza impiego di risorse fossili (LICENCE RPP200069). Il materiale, tecnopolimero caricato, è riciclabile al 100%, resistente e duraturo. La sedia è stata progettata per ambienti interni ed esterni.

The designer Nicholas Baker to achieve this unique silhouette, developed the concept starting from a rectangular figure that he modeled with the aid of the VR viewer until obtaining a sinuous and fluid shape, immediately recognizable. Super Chair is produced with injection molding technology in recycled polypropylene made through RE-LIFE® technology and the polymeric part is obtained from the recycling of offcuts and industrial waste without the use of fossil resources (LICENCE RPP200069). The material being a filled technopolymer is 100% recyclable, resistant and long-lasting. The chair is designed for indoor and outdoor environments.

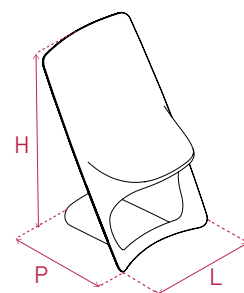

Kg.	5.9
L - cm.	53.5
H - cm.	85.7
P - cm.	57.0

PLASTICA / PLASTIC

Colori Super Chair
Super Chair colors



Bianco
White



Grigio
Grey



Nero
Black



Amaranto
Amaranth



Senape
Mustard



Cuoio
Leather



Blu
Blue

VERTICAL LINE

Vertical Line è un sistema modulare per comporre pareti attrezzate e divisori costituito da montanti e traversi di alluminio. Applicabile tra pavimento e soffitto Vertical Line funge da elegante divisorio tra la cucina e il living, creando un filtro permeabile tra i diversi ambienti. La sua versatilità le permette di essere utilizzata anche come divisorio tra lo spazio giorno e notte o come mobile per arredare il living accogliendo la TV, e il design moderno e minimale si adatta a vari contesti domestici e lavorativi. Vertical Line è disponibile anche completa di illuminazione LED ed è personalizzabile con mensole di legno, metallo o vetro, contenitori chiusi e pannelli in legno.

Vertical Line is a modular floor to ceiling structure that consists of aluminium studs and crossbeams. Vertical Line is an elegant dividing bookcase between the kitchen and the living room, creating a permeable filter between the different rooms. Thanks to its versatile and modern design, Vertical Line is suitable for homes, retail shops and work spaces. This structure is also available with LED lighting and it is customisable with wooden, metal or glass shelves, wooden cabinets and panels.

Design

Damiano Latini

Informazioni tecniche

p. 48







VERTICAL LINE

Alluminio / Aluminium

La libreria Vertical Line è composta da montanti e traversi in alluminio che donano alla struttura linee semplici e pulite senza rinunciare alla sua funzione principale. Questa libreria, infatti, è dotata di una buona forza strutturale: ogni barra può supportare un carico fino a 30 kg. I piedini regolabili si fissano a pressione tra soffitto e pavimento per una maggiore stabilità e permettono di coprire diverse altezze, grazie a un'escursione totale di circa 10 cm. In ogni barra sono presenti dei fori passanti, posizionati centralmente, per il fissaggio delle mensole, una volta montate i fori rimangono nascosti.

Vertical Line is a floor-ceiling bookcase with a light and minimal structure, composed of aluminium studs and crossbeams. However this bookcase is very stable and each crossbeam can hold up to 30 Kg. The rotating feet allow you to adjust the studs height up to 10 cm and keep the structure stable. Shelves need to be screwed on the crossbeams.

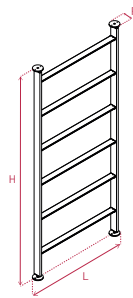

	H 238	H 268	H 288
H (min - max) - cm.	238.0 - 248.0	268.0 - 278.0	288.0 - 298.0
L (traverso 60 - cm.)	72.9	72.9	72.9
L (traverso 75 - cm.)	87.9	87.9	87.9
L (traverso 90 - cm.)	102.9	102.9	102.9
L (traverso 120 - cm.)	132.9	132.9	132.9
P - cm.	10.0	10.0	10.0

ACCESSORI / ACCESSORIES

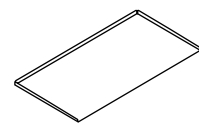

Mensola metallo
Metal shelf

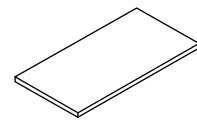

Mensola legno
Wooden shelf

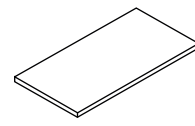

Mensola vetro
Glass shelf

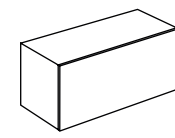

Pensile
Cabinet

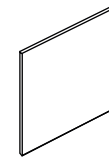

Pannello
Panel

METALLO / METAL

Finiture struttura e mensole
Structure and shelves finishes



Bianco
White



Ghisa
Cast iron



Titanio
Titanium



Bronzo
Bronze



Nero
Black

LEGNO / WOOD

Finiture mensole, pensili e pannelli
Shelves, cabinets and panels finishes

Legno impiallacciato/Veneered wood



Noce canaletto
Canaletto walnut



Rovere spaccato
Split durmast

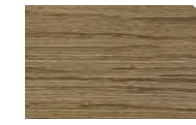

Rovere dove
Dove durmast



Rovere dark
Dark durmast



Frassino bianco
White ash



Frassino nero
Black ash

Legno laccato/Lacquered wood



Nero opaco
Matte black



Bianco opaco
Matte white



Grigio opaco
Matte grey

Legno melaminico/Melamine wood



Rovere ortisei
Ortisei durmast



Noce tundra
Tundra walnut

VETRO / GLASS

Finiture mensole
Shelves finishes

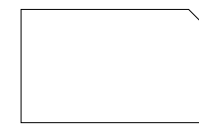

Extra light
Extra light



Extra light ricotto
Annealed extra light



Fumé
Fumé

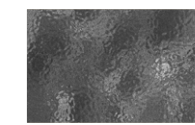

Fumé ricotto
Annealed fumé







VERTICAL LINE LUX

Alluminio / Aluminium



Vertical Line Lux è una libreria divisoria con illuminazione LED integrata ai traversi. La struttura è dotata anche di telecomando per controllare l'accensione /spegnimento e regolare l'intensità della luce. L'illuminazione LED non solo consente di risparmiare energia, ma contribuisce all'arredamento della casa, creando un ambiente più intimo.

Vertical Line Lux is a floor-to-ceiling bookcase with LED lighting integrated into the crossbeams. The structure is also equipped with a remote control to switch on / off and adjust the intensity of the light. LED lighting not only help to save energy, but also contributes to the decor of the home, creating a more intimate environment.

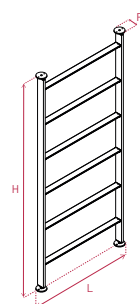

	H 238	H 268	H 288
H (min - max) - cm.	238.0 - 248.0	268.0 - 278.0	288.0 - 298.0
L traverso 60 - cm.	72.9	72.9	72.9
L traverso 75 - cm.	87.9	87.9	87.9
L traverso 90 - cm.	102.9	102.9	102.9
L traverso 120 - cm.	132.9	132.9	132.9
P - cm.	10.0	10.0	10.0

ACCESSORI / ACCESSORIES

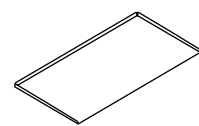

Mensola metallo
Metal shelf

METALLO / METAL

Finiture struttura e mensole
Structure and shelves finishes



Bianco
White

Ghisa
Cast iron

Titanio
Titanium

Bronzo
Bronze

Nero
Black

GIOSTRA-L

Organizzare lo spazio con eleganza e, al contempo, secondo criteri di efficienza, questa è, in sintesi, Giostra-L. La struttura di alluminio composta da traversi e montanti verticali fissati a parete si può personalizzare con mensole di legno, metallo o vetro e contenitori chiusi di legno. Grazie alla struttura modulare e alla possibilità di realizzare soluzioni su misura, Giostra-L può fungere non solo da libreria ma anche da parete attrezzata per il soggiorno. Giostra-L è disponibile anche con illuminazione LED integrata.

Giostra-L is a customisable solution designed to organise space in a smart way. The aluminium frame composed of crossbeams and wall-mounted vertical studs, is customisable with wooden, metal and glass shelves and wooden cabinets. Thanks to its modular structure and many possible configurations, Giostra-L can work as bookcase or wall unit for the living room. Giostra-L is also available with integrated LED lighting.

Design

Damiano Latini

Informazioni tecniche

p. 66







GIOSTRA-L

Alluminio / Aluminium

Giostra-L condivide con Vertical Line e Giostra-C la medesima struttura di metallo, ma a differenza delle altre Giostra-L poggia sul pavimento ed è ancorata alla parete. Le sue linee minimali, i diversi moduli e la forza strutturale la rendono perfetta per ogni ambiente. Giostra-L è dotata di piedini regolabili nella parte inferiore così da avere un'escursione di circa 5 cm. In ogni barra sono presenti dei fori passanti, posizionati centralmente, per il fissaggio delle mensole, una volta montate i fori rimangono nascosti.

Giostra-L is a wall-mounted bookcase that shares with Vertical Line and Giostra-C the same design and structure. Thanks to its clean lines, modular design and frame strength, Giostra-L is perfect for many different environments. Giostra-L is equipped with rotating feet and it can adjust height up to 5 cm. Shelves need to be screwed on the crossbeams.

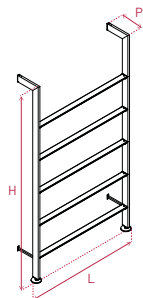

	H 208	H 238	H 268
H - cm. (min - max)	208.0 - 213.0	238.0 - 243.0	268.0 - 273.0
L trasverso 60 - cm.	72.9	72.9	72.9
L trasverso 75 - cm.	87.9	87.9	87.9
L trasverso 90 - cm.	102.9	102.9	102.9
L trasverso 120 - cm.	132.9	132.9	132.9
P - cm.	29.7	29.7	29.7

ACCESSORI / ACCESSORIES

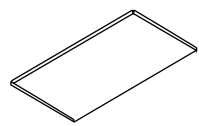

Mensola metallo
Metal shelf

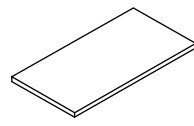

Mensola legno
Wooden shelf

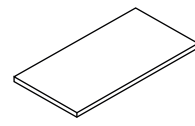

Mensola vetro
Glass shelf

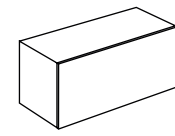

Pensile
Cabinet

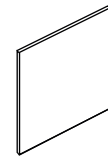

Pannello
Panel

METALLO / METAL

Finiture struttura e mensole
Structure and shelves finishes



Bianco
White



Ghisa
Cast iron



Titanio
Titanium



Bronzo
Bronze



Nero
Black

LEGNO / WOOD

Finiture mensole, pensili e pannelli
Shelves, cabinets and panels finishes

Legno impiallacciato/Veneered wood



Noce canaletto
Canaletto walnut



Rovere spaccato
Split durmast

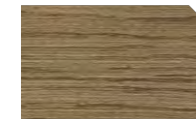

Rovere dove
Dove durmast



Rovere dark
Dark durmast



Frassino bianco
White ash



Frassino nero
Black ash

Legno laccato/Lacquered wood



Nero opaco
Matte black



Bianco opaco
Matte white



Grigio opaco
Matte grey

Legno melaminico/Melamine wood



Rovere ortisei
Ortisei durmast



Noce tundra
Tundra walnut

VETRO / GLASS

Finiture mensole
Shelves finishes

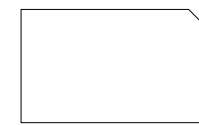

Extra light
Extra light



Extra light ricotto
Annealed extra light



Fumé
Fumé

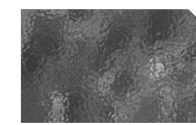

Fumé ricotto
Annealed fumé





GIOSTRA-L LUX

Alluminio / Aluminium



Le nostre illuminazioni integrate da collocare sotto alla traversa orizzontale donano atmosfera, funzionalità e stile. I LED non solo consentono di risparmiare energia, ma grazie a un'illuminazione diffusa, contribuiscono a creare un ambiente rilassato e accogliente.

Our integrated lighting to be placed under the horizontal crossbar enhance our furniture features making them extremely stylish and functional. LED lighting is not only the most energy efficient option on the market but, thanks to light diffusion, it also helps to create a relaxing and pleasant ambience.

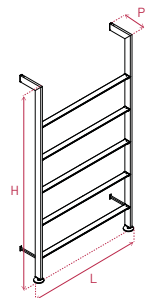

	H 208	H 238	H 268
H - cm. (min - max)	208.0 - 213.0	238.0 - 243.0	268.0 - 273.0
L traverso 60 - cm.	72.9	72.9	72.9
L traverso 75 - cm.	87.9	87.9	87.9
L traverso 90 - cm.	102.9	102.9	102.9
L traverso 120 - cm.	132.9	132.9	132.9
P - cm.	29.7	29.7	29.7

ACCESSORI / ACCESSORIES

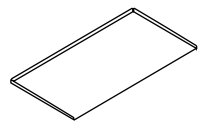

Mensola metallo
Metal shelf

METALLO / METAL

Finiture struttura e mensole
Structure and shelves finishes



Bianco
White

Ghisa
Cast iron

Titanio
Titanium

Bronzo
Bronze

Nero
Black

GIOSTRA - C

Giostra-C è una libreria sospesa a parete che insieme alla libreria pavimento-parete Giostra-L e al divisorio Vertical Line forma un trittico di strutture modulari che coprono tutte le esigenze di organizzazione degli spazi in un ambiente. Giostra- C è disponibile anche nella versione illuminata e può essere realizzata su misura.

Giostra-C is a wall-mounted bookcase which, together with the Giostra-L floor-to-wall bookcase and the Vertical Line divider, forms a triptych of modular structures that cover all the space organization needs in an environment. Giostra-C is also available in the illuminated version and can be tailor-made.

Design

Damiano Latini

Informazioni tecniche

p. 82







GIOSTRA-C

Alluminio / Aluminium

Giostra-C, a differenza di Vertical Line e Giostra-L è una libreria sospesa a parete. Le sue linee pulite si adattano ad ogni stile e ambiente della casa, il suo montaggio a parete è semplice e ha una grande capacità di carico. In ogni barra sono presenti dei fori passanti, posizionati centralmente, per il fissaggio delle mensole. Una volta montate i fori rimangono nascosti.

Giostra-C unlike Vertical Line and Giostra-L is a suspended bookcase. Thanks to its clean lines it can adapt to every space and style. Giostra-C wall-mounting system is easy and it allows a great weight load. Shelves need to be screwed on the crossbeams.

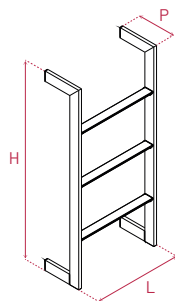

	H 145	H 180
H - cm. (min - max)	145.0	180.0
L traverso 60 - cm.	65.3	65.3
L traverso 75 - cm.	80.3	80.3
L traverso 90 - cm.	95.3	95.3
L traverso 120 - cm.	125.3	125.3
P - cm.	28.5	28.5

ACCESSORI / ACCESSORIES

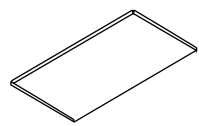

Mensola metallo
Metal shelf

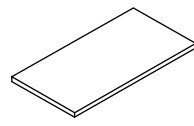

Mensola legno
Wooden shelf

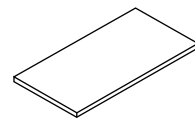

Mensola vetro
Glass shelf

METALLO / METAL

Finiture struttura e mensole
Structure and shelves finishes



Bianco
White



Ghisa
Cast iron



Titanio
Titanium



Bronzo
Bronze



Nero
Black

LEGNO / WOOD

Finiture mensole, pensili e pannelli
Shelves, cabinets and panels finishes

Legno impiallacciato/Veneered wood



Noce canaletto
Canaletto walnut



Rovere spaccato
Split durmast

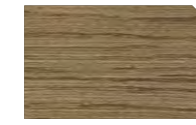

Rovere dove
Dove durmast



Rovere dark
Dark durmast



Frassino bianco
White ash



Frassino nero
Black ash

Legno laccato/Lacquered wood



Nero opaco
Matte black



Bianco opaco
Matte white



Grigio opaco
Matte grey

Legno melaminico/Melamine wood



Rovere ortisei
Ortisei durmast



Noce tundra
Tundra walnut

VETRO / GLASS

Finiture mensole
Shelves finishes

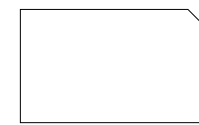

Extra light
Extra light



Extra light ricotto
Annealed extra light



Fumé
Fumé

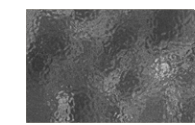

Fumé ricotto
Annealed fumé

GIOSTRA

Bifacciale, funzionale, leggera. Giostra è una struttura divisoria bifacciale progettata per dividere gli spazi in modo razionale senza rinunciare alla luminosità negli ambienti. Grazie al design minimal e moderno e alla struttura modulare, Giostra si integra perfettamente a qualsiasi ambiente, domestico o lavorativo, rendendolo più funzionale senza alterarne radicalmente la struttura. Applicabile semplicemente tra pavimento e soffitto, Giostra è estremamente versatile e personalizzabile con un'ampia varietà di accessori.

Bifacial, functional, light. Giostra is a bifacial dividing structure designed to divide space rationally and keep the rooms bright. Thanks to a minimal and modern design and its modular structure, Giostra fits perfectly in either domestic or work spaces, making them more functional. Giostra floor-to-ceiling structure is extremely versatile and customisable with a wide variety of accessories.

Design

Marcello Santini

Informazioni tecniche

p. 92







GIOSTRA

Alluminio / Aluminium

Giostra è un complemento di arredo bifacciale e modulare. Tuttavia possiamo realizzare soluzioni su misura adattabili al contesto dove sono installate. Gli accessori si agganciano direttamente ai traversi e ciascun lato della struttura può essere personalizzato con accessori diversi. Grazie alle due barre orizzontali fissate sul montante verticale, Giostra è in grado di formulare molteplici soluzioni per la definizione architettonica degli ambienti. Con una sola struttura è possibile attrezzare due zone distinte, mantenendo sempre un design leggero e moderno.

Giostra is a modular, bifacial, dividing wall available in modules. However we can realise bespoke solutions to adapt the structure to the client's needs. Accessories are hooked to the crossbeams and it is possible to customise each side of the structure with different accessories. Thanks to the two horizontal bars fixed to the vertical pillar, Giostra can offer multiple solutions for the architectural definition of the spaces. Just one single structure can furnish two distinct areas and yet keep a modern and smart design.

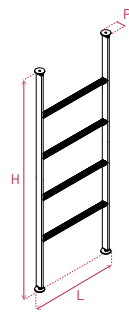

	H 266
H - cm. (min - max)	266.00 - 276.00
L (traverso 90) - cm.	102.8
L (traverso 90+90) - cm.	195.6
P - cm.	10.0

ACCESSORI / ACCESSORIES

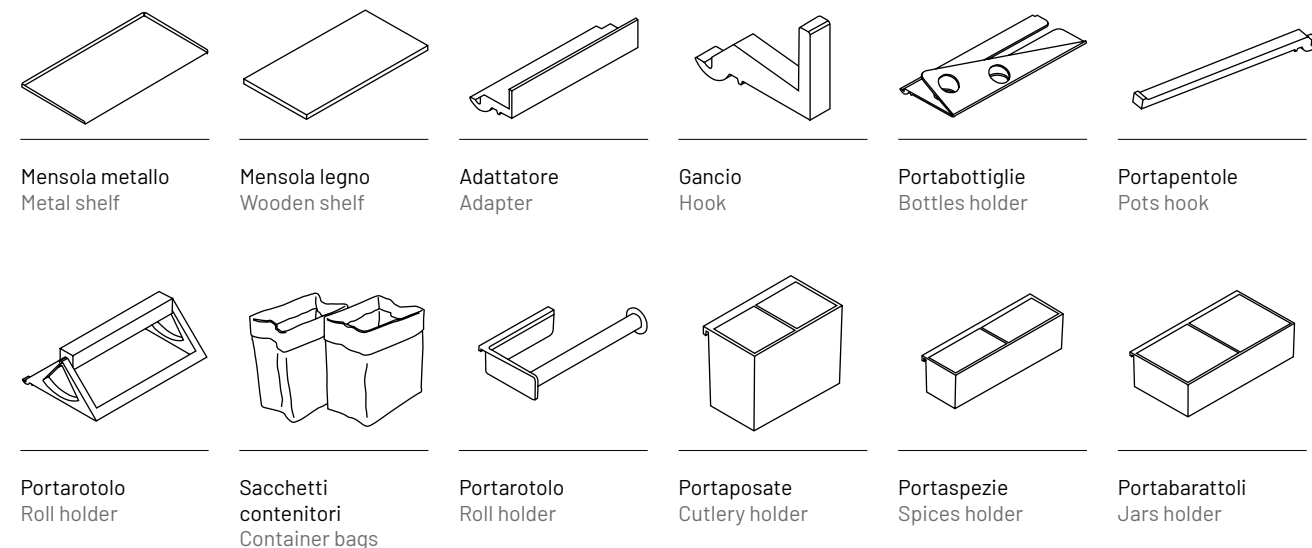

METALLO / METAL

Finiture struttura, mensole, adattatore, gancio, portabottiglie e portapentole
Structure, shelves, adapter, hook, bottles holder and pots hook finishes

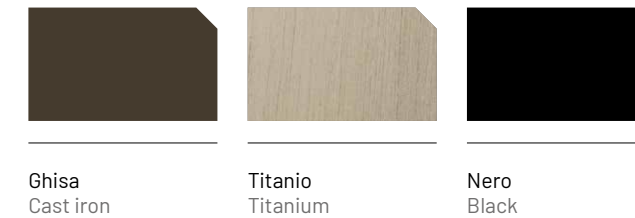

LEGNO / WOOD

Finiture mensole
Shelves finishes

Legno impiallacciato/Veneered wood



Legno laccato/Lacquered wood



Legno melaminico/Melamine wood

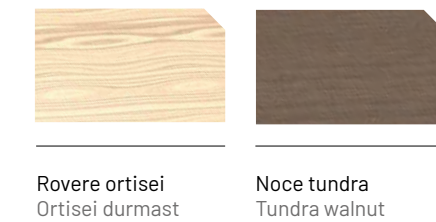

PLASTICA / PLASTIC

Finiture portarotolo, portaposate, portaspezie e portabarattoli
Roll holder, cutlery holder, spices holder, jars holder finishes

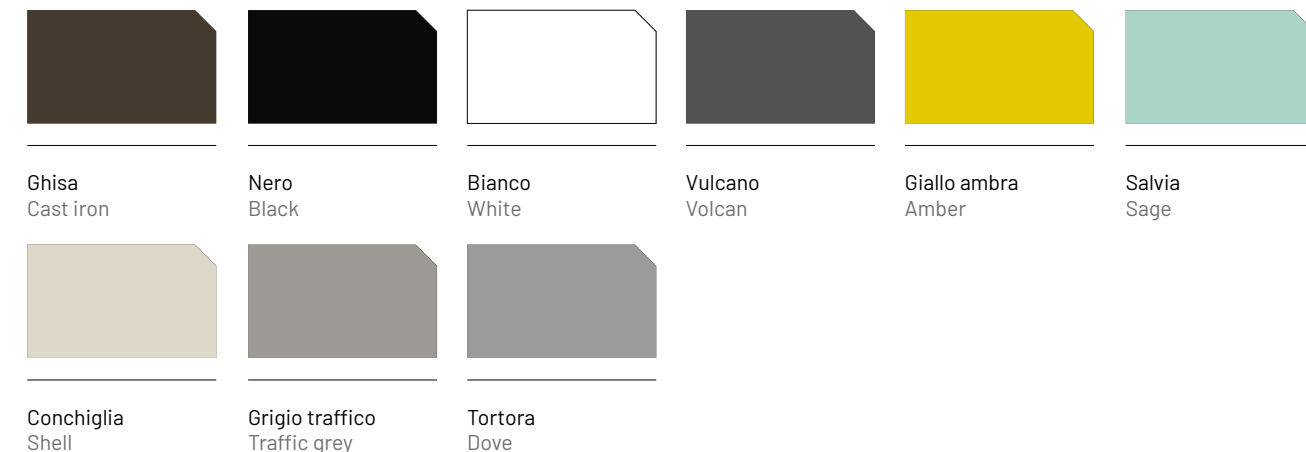

IO

IO è un sistema sospeso di mensole e accessori progettato per arredare bagni di tutte le dimensioni. Grazie al design versatile e alla modularità della struttura, IO consente di ottimizzare lo spazio mantenendo l'appeal estetico. Disponibile in due moduli, singolo o doppio, IO si fissa al soffitto per scendere sospeso sopra al lavabo. Design essenziale e versatilità sono le caratteristiche chiave che rendono IO una soluzione di arredo bagno funzionale ed elegante, ideale per la casa e per il mondo dell'ospitalità.

IO is a suspended open storage system especially suitable for smaller bathrooms. Thanks to a flexible design, custom height and width, IO is a tailor-made solution that allows to maximize storage spaces while keeping the aesthetics appeal. IO is a suspended open storage system designed to furnish any type of bathroom. There are two possible modules available, single and double, both fastened to the ceiling and suspended over the washbasin. Essential design and flexibility are the key distinctive features that make IO a smart bathroom furnishing solution for homes and the hospitality industry.

Design
Nunzia Ponsillo
Design Studio

Informazioni tecniche
p. 102









IO

Alluminio / Aluminum

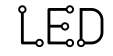

220 V
110 V



La struttura di IO è essenziale ed elegante, valorizzata dall'illuminazione LED che ne disegna i contorni. Il montante verticale è dotato di una cava posteriore per ospitare la strip LED e di due binari laterali per agganciare i profili orizzontali. Le barre orizzontali possono scorrere lungo il binario ed essere fissate all'altezza preferita. Lo specchio è dotato di un sistema d'illuminazione D-Motion e di controllo con tre interruttori touch che attivano l'accensione e lo spegnimento delle sorgenti luminose, la selezione della temperatura colore (2700 K o 4000 K) e l'attivazione del sistema anti-appannamento.

IO structure is essential and elegant, enhanced by the LED lighting that outlines its contours. The vertical profiles have a back groove to hold the LED strip and two side binaries for the horizontal profiles. The horizontal bars can move along the binary and be easily fixed at the preferred distance. The mirror is equipped with a D-Motion lighting and control system with three touch switches that activate the switching on and off of light sources, the color temperature selection (2700 K or 4000 K) and the activation of the anti-fog system.

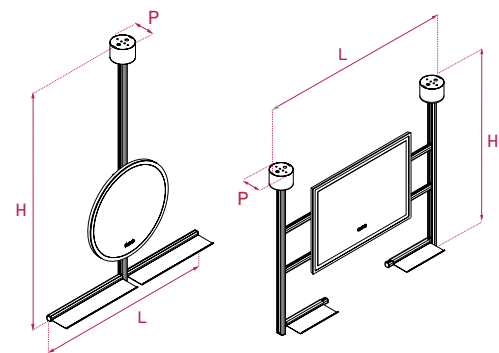

	IO-S	IO-D
L - cm.	114.0	137.4
H - cm.	157.5	157.5
P - cm.	21.8	21.7

ACCESSORI / ACCESSORIES

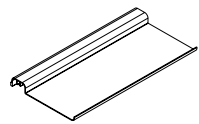

Mensola metallo
Metal shelf

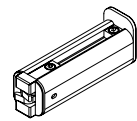

Gancio
Hook

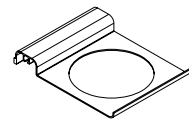

Mensola porta phon/
bicchiere
Hairdryer/glass
holder shelf

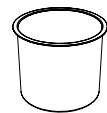

Contenitore
Container

METALLO / METAL

Finiture struttura e accessori
Structure and accessories finishes



Titanio
Titanium



Bronzo
Bronze



Nero
Black

lo-L

lo-L è una libreria modulare con fissaggio pavimento-parete. Questo complemento di arredo si caratterizza per la rotondità delle sue linee e l'illuminazione LED integrata ai montanti. La luce diffusa dal retro della struttura si riflette sulla parete creando un'atmosfera intima ideale per la zona living.

lo-L is a modular bookcase with floor-wall fixing. This piece of furniture is characterized by the roundness of its lines and the LED lighting integrated into the uprights. The diffused light from the back of the structure reflects on the wall, creating an intimate atmosphere ideal for the living area.

Design

**Damiano Latini
&
Nunzia Ponsillo
Design Studio**

Informazioni tecniche
p. 112







IO - L

Alluminio / Aluminum

LED  220 V 

Abbiamo interpretato IO-L anche come una struttura modulare porta accessori per il bagno, a completamento della struttura IO con cui condivide i montanti in alluminio. La struttura è dotata di mensole in metallo e telecomando per controllare l'illuminazione a distanza.

We have also interpreted IO-L as a modular structure for bathroom accessories, to complete the IO structure with which it shares the aluminum uprights. The structure is equipped with metal shelves and remote control to control the lighting from a distance.

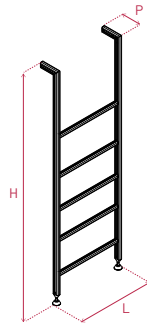

	H 208	H 238
H - cm. (min - max)	208.0-210.0	238.0-240.0
L traverso 60 - cm.	69.2	69.2
L traverso 90 - cm.	99.2	99.2
P - cm.	30.1	30.1

ACCESSORI / ACCESSORIES

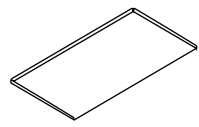

Mensola metallo
Metal shelf

METALLO / METAL

Finiture struttura e mensole
Structure and shelves finishes



Titanio
Titanium



Bronzo
Bronze



Nero
Black

SHELL

Dinamico e contemporaneo Shell è una struttura completamente personalizzabile. Grazie ad una struttura estremamente semplice, composta da una doppia cornice in metallo e mensole in legno, è possibile realizzare moltissime composizioni, anche angolari. Le cornici in metallo, fissate alle pareti, sostengono le mensole attraverso appositi supporti.

Dynamic and contemporary, Shell is completely customisable. Thanks to an extremely simple structure composed of two metal frames and wooden shelves, you can create many different compositions. The metal frames, fastened to the wall, hold the wooden shelves through a couple of brackets.

Design

Nicola Checchi

Informazioni tecniche

p. 122







SHELL

Acciaio / Steel

Shell è una libreria sospesa modulare, dalle linee semplici e caratterizzanti. I moduli composti da una, due, quattro o sei mensole possono dar luogo a infinite composizioni e adattarsi ad ogni ambiente della casa. Le cornici in metallo che lo compongono possono essere allineate per un design più pulito oppure asimmetriche (spostate di 5 cm) così da creare un effetto più dinamico.

Shell is a modular wall-mounted bookcase with a contemporary design. This bookcase is composed of double frames that hold wooden shelves. Each module is available in three different heights and can hold 1, 2, 4 or 6 shelves. Combining double frames and wooden shelves you can create endless combinations and furnish any kind of wall. The metal frames can be aligned or skewed for a more dynamic design.

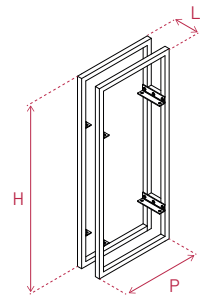

	H 26	H 60	H 128	H 196
L - cm.	8.0	8.0	8.0	8.0
P - cm.	25.4	25.4	25.4	25.4

ACCESSORI / ACCESSORIES

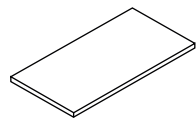

Mensola legno
Wooden shelf

METALLO / METAL

Finiture struttura Structure finishes

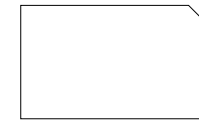

Bianco
White



Antracite
Anthracite



Bronzo
Bronze



Nero
Black

LEGNO / WOOD

Finiture mensole Shelves finishes

Legno impiallacciato/Veneered wood



Noce canaletto
Canaletto walnut



Rovere spaccato
Split durmast

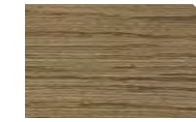

Rovere dove
Dove durmast



Rovere dark
Dark durmast



Frassino bianco
White ash



Frassino nero
Black ash

Legno laccato/Lacquered wood



Nero opaco
Matte black

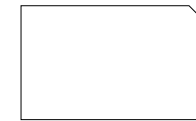

Bianco opaco
Matte white



Grigio opaco
Matte grey

Legno melaminico/Melamine wood



Rovere ortisei
Ortisei durmast



Noce tundra
Tundra walnut

OUTLINE

Semplice e versatile. Outline è la libreria modulare adatta ad arredare ogni ambiente della casa. Le cornici in metallo appoggiate a terra alloggiavano mensole in legno, regolabili in altezza, che permettono di ospitare in maniera pratica oggetti dalle altezze più varie. Componibile secondo diversi moduli, è il complemento ideale per la casa e l'ufficio.

Versatile and linear, Outline is the modular bookcase suitable for any room. The metal frames, placed on the ground, hold wooden shelves, adjustable in height, which allow to put different objects in a practical way. The multiple possible combinations and its clean design make it an unmissable piece of furniture for any home or office.

Design

Damiano Latini

Informazioni tecniche

p. 132







OUTLINE

Alluminio / Aluminium

Una semplicità architettonica che assicura al progetto un'eccezionale versatilità, con la possibilità di realizzare composizioni di ampie dimensioni in assoluta sicurezza. Grazie ai piedini di regolazione i montanti possono essere allineati e messi in tensione in modo stabile in tutta semplicità.

Outline features an architectural simplicity that makes this project very versatile and safe even when developed in large compositions. Thanks to the regulating feet the studs can be easily aligned to keep the whole structure stable.

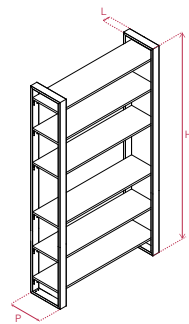

L - cm.	7.50
H - cm. (min - max)	217.0
P - cm.	35.60

ACCESSORI / ACCESSORIES

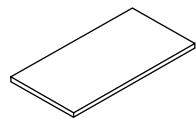

Mensola legno
Wooden shelf

METALLO / METAL

Finiture struttura Structure finishes



Bianco
White

Titanio
Titanium

Bronzo
Bronze

Nero
Black

LEGNO / WOOD

Finiture mensole Shelves finishes

Legno impiallacciato/Veneered wood

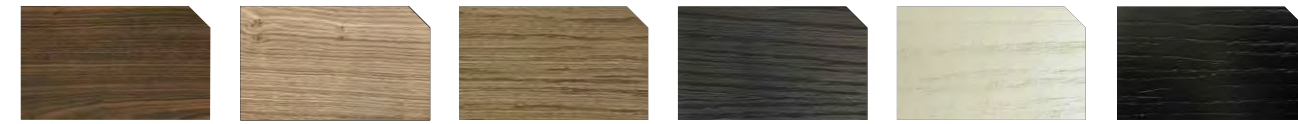

Noce canaletto
Canaletto walnut

Rovere spaccato
Split durmast

Rovere dove
Dove durmast

Rovere dark
Dark durmast

Frassino bianco
White ash

Frassino nero
Black ash

Legno laccato/Lacquered wood

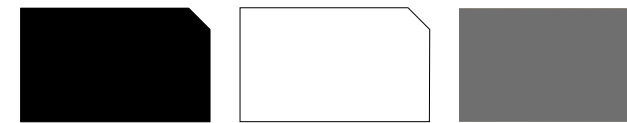

Nero opaco
Matte black

Bianco opaco
Matte white

Grigio opaco
Matte grey

Legno melaminico/Melamine wood

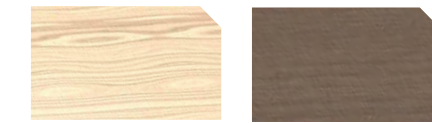

Rovere ortisei
Ortisei durmast

Noce tundra
Tundra walnut

CELLULA

Cellula è un portabottiglie di design espressione della convivialità e invito alla condivisione. Il design parte da un cerchio, forma geometrica perfetta, che al suo interno accoglie la bottiglia protagonista della scena. Inoltre, la linea continua del cerchio rimanda alla fluida gestualità del "versare in un calice" e quindi al piacere del vino. Grazie al design essenziale ed elegante e alla struttura modulare, Cellula è un complemento di arredo ideale per arredare sia ambienti domestici sia ristoranti.

Cellula is a design bottles holder, expression of conviviality and wine sharing. The design starts from a circle, a perfect geometric shape, which host the bottle that is the protagonist of the scene. Furthermore, the continuous line of the circle refers to the fluid gestures of "pouring into a glass" and therefore to the pleasure of wine. Thanks to the essential and elegant design and the modular structure, Cellula is an ideal piece of furniture to furnish both domestic environments and restaurants.

Design
Luigi Ponticiello

Informazioni tecniche
p. 142







CELLULA

Acciaio / Steel

Cellula è composto da moduli di sei cilindri di lamiera, lavorati al laser e curvati per contenere al suo interno la bottiglia in posizione obliqua. La struttura può essere poggiata al pavimento o fissata sospesa a parete, si possono inoltre combinare più moduli per creare composizioni più ampie.

Cellula is made up of modules of six sheet metal cylinders, laser-worked and curved to contain the bottle in an oblique position inside. The structure can be placed on the ground or fixed to the wall, and it is also possible to combine several modules to create larger compositions.

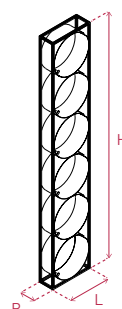

L - cm.	30.0
H - cm.	171.0
P - cm.	11.0

METALLO / METAL

Finiture struttura
Structure finishes



Bronzo
Bronze



Nero
Black

CAOS

Caos è un moderno portabottiglie da parete che svolge anche una funzione decorativa. Formato da un'unica unità ripetibile potenzialmente all'infinito, Caos è un intreccio di linee orizzontali e verticali volte a creare un disegno astratto. La struttura modulare consente di sviluppare il portabottiglie in orizzontale o in verticale e di arredare pareti di qualsiasi dimensioni. In alternativa, Caos può essere dotato di mensoline in legno da utilizzare come porta oggetti, diventando così un bellissimo complemento d'arredo per il soggiorno.

Caos is a modern wall-mounted bottles holder and a fantastic decorative element to add to your house. Caos is one single melded piece that can be endlessly repeated. Caos is a twist of horizontal and vertical lines that designs an abstract shape. The modular structure allows you to vertically or horizontally develop the bottles holder to decor any type of walls. Alternatively Caos can be equipped with small wooden shelves.

Design

Damiano Latini

Informazioni tecniche

p. 152







CAOS

Acciaio / Steel

Le cornici in acciaio della struttura Caos sono saldate in unico pezzo e sono disegnate per reggere 6 bottiglie in orizzontale. In alternativa è possibile personalizzare la struttura con le mensole, semplicemente avvitandole da sotto dove sono presenti appositi fori.

Caos steel frames are welded together in one single piece and they can hold up to 6 bottles. Alternatively it is possible to customise the frame with wooden shelves, fixed to the structure through screws.

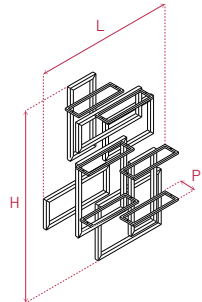

L - cm.	77.00
H - cm.	108.50
P - cm.	13.00

ACCESSORI / ACCESSORIES

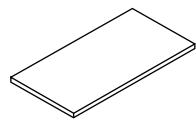

Mensola legno
Wooden shelf

METALLO / METAL

Finiture struttura Structure finishes



Bronzo
Bronze



Nero
Black

LEGNO / WOOD

Finiture mensole Shelves finishes

Legno impiallacciato/Veneered wood



Noce canaletto
Canaletto walnut



Rovere spaccato
Split durmast

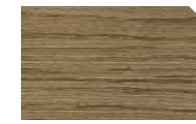

Rovere dove
Dove durmast



Rovere dark
Dark durmast



Frassino bianco
White ash



Frassino nero
Black ash

Legno laccato/Lacquered wood



Nero opaco
Matte black



Bianco opaco
Matte white



Grigio opaco
Matte grey

Legno melaminico/Melamine wood



Rovere ortisei
Ortisei durmast



Noce tundra
Tundra walnut

TOWER S

Tower è una libreria modulare dal design pulito ed essenziale. I montanti disponibili in varie altezze combinati con le mensole di legno consentono di creare molteplici configurazioni diverse. La struttura si compone di montanti fissati a parete che sorreggono le mensole, mediante reggimensola.

Tower is a modular bookcase with a minimal and essential design. The vertical studs are available in various heights in order to compose your bespoke solution. The bookcase is customisable with wooden shelves. The structure is composed of wall-mounted metal studs that hold the wooden shelves through metal supports.

Design

Damiano Latini

Informazioni tecniche

p. 162







TOWER S

Acciaio / Steel

Design sofisticato e ingombri minimi caratterizzano questa libreria. I suoi reggimensola in acciaio donano grande solidità alla struttura e una buona capacità di carico alle mensole. Le lamiere piegate e sagomate si inseriscono nelle mensole, così da avere altro spazio per stoccare gli oggetti e donare alla struttura un aspetto ancora più unico.

A sophisticated and minimal design bookcase and yet very sound. The shelves supports ensure a good weight capacity of shelves. The folded metal sheets insert themselves on the shelves so you can customise the bookcase and have additional storage space.

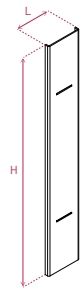

	H 65	H 101	H 137	H 173
L - cm.	10.00	10.00	10.00	10.00
P - cm.	1.20	1.20	1.20	1.20

ACCESSORI / ACCESSORIES

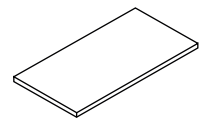

Mensola legno
Wooden shelf

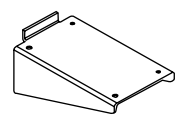

Reggimensola
Shelf support

METALLO / METAL

Finiture struttura Structure finishes



Ghisa
Cast iron

LEGNO / WOOD

Finiture mensole Shelves finishes

Legno impiallacciato/Veneered wood



Noce canaletto
Canaletto walnut



Rovere spaccato
Split durmast



Rovere dove
Dove durmast



Rovere dark
Dark durmast



Frassino bianco
White ash



Frassino nero
Black ash

Legno laccato/Lacquered wood



Nero opaco
Matte black



Bianco opaco
Matte white



Grigio opaco
Matte grey

Legno melaminico/Melamine wood



Rovere ortisei
Ortisei durmast

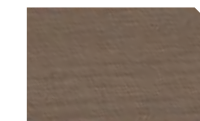

Noce tundra
Tundra walnut

K U B I

Una libreria a parete modulare dal design essenziale risultato della ripetizione di una forma base principale. Il designer Nicola Checchi per Kubi, si è ispirato al cubo come elemento primario e lo ha ruotato di 45 gradi per donare dinamicità alla composizione. Nella vista di tre quarti è visibile un gioco di pieni e vuoti effetto scacchiera e al dinamismo delle forme si aggiunge quello dei colori, grazie all'ampia varietà delle colorazioni possibili. Kubi è una libreria composta da due elementi in lamiera piegata saldati insieme, e dotata di due alette nel retro, che permettono di fissare la struttura alla parete.

A modular wall bookcase with an essential design resulting from the repetition of a main basic shape. Kubi, designed by Nicola Checchi, was inspired by the cube as a primary element and rotated it 45 degrees to give dynamism to the composition. In the three-quarter view you can see a game of solids and voids with a checkerboard effect and the dynamism of the shapes is joined by that of the colors, thanks to the wide variety of possible shades. Kubi is a bookcase made up of two folded metal sheet welded together, and two flaps on the back to fix the structure to the wall.

Design

Nicola Checchi

Informazioni tecniche

p. 172







KUBI

Acciaio / Steel

Semplice da installare, la libreria Kubi è composta da due elementi saldati insieme. L'altezza di 30 cm consente di inserire all'interno anche libri di grande formato o bottiglie.

Kubi wall-mounted bookcase is easy to mount, and it consists of two elements welded together. Each element is 30 cm high to store books or bottles.

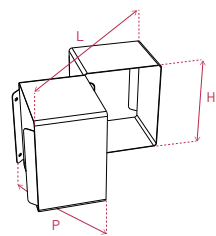

L - cm.	63.80
H - cm.	30.00
P - cm.	31.90

METALLO / METAL

Finiture struttura
Structure finishes



Ghiaccio
Ice



Rame
Copper



Nero
Black



Verde giungla
Jungle green



Zirconio
Zirconium

JOIN

Figure geometriche e colori che si intersecano per dare forma a un tavolino da salotto moderno e multifunzionale. Un progetto fortemente identitario e riconoscibile nonostante l'utilizzo di forme semplici ed essenziali. Realizzato per arredare il soggiorno, Join è perfetto come coffee table e portariviste ma anche come comodino per la camera da letto. Disponibile in cinque colori per la fascia di sostegno e due per il basamento, accostabili liberamente, si adatta a diversi stili e mood, portando colore dove è necessario.

Two geometrical figures and two colours combined to shape a modern and functional coffee table. A project with a strong identity despite the use of simple and essential shapes. Join is designed as a coffee table and magazine holder for the living room but it can be used as a bedside table too. The support band is available in five colours that you can combine with the two bases shades. You can choose your preferred colours combo.

Design

Nicola Pantanetti

Informazioni tecniche

p. 182







JOIN

Acciaio / Steel

Leggero e facile da spostare, il tavolino Join può essere utilizzato come porta riviste e per appoggiare oggetti. I due componenti si uniscono tra di loro semplicemente ad incastro, infatti nella base in alluminio sono presenti 4 dentini che si vanno ad inserire nelle 4 asole della fascia.

Light and easy to move, Join can be used either to store magazines or as a coffee table. It is composed of two elements dovetailed together.

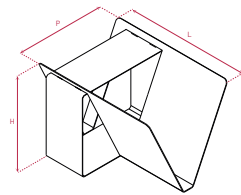

Kg.	8.60
L - cm.	61.00
H - cm.	41.70
P - cm.	47.00

METALLO / METAL

Finiture struttura
Structure finishes

BASAMENTO
BASE

FASCIA
BAND



Ghiaccio
Ice

Nero
Black

Ghiaccio
Ice

Rame
Copper

Nero
Black

Zirconio
Zirconium

Verde giungla
Jungle green

#DESIGNTOSURPRISE

INDICE PER IMMAGINI

VISUAL INDEX

SUPER CHAIR pag.18

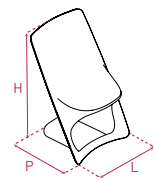

Bianco White
Grigio Grey
Nero Black
Amaranto Amaranth
Senape Mustard



Cuio Leather
Blu Blue

VERTICAL LINE pag.40

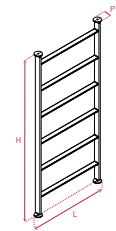

Bianco White
Ghisa Cast iron
Titanio Titanium
Bronzo Bronze
Nero Black

GIOSTRA-L pag.58

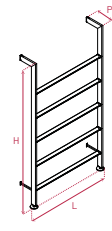

Bianco White
Ghisa Cast iron
Titanio Titanium
Bronzo Bronze
Nero Black

CELLULA pag.134

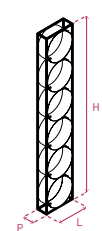

Bronzo Bronze
Nero Black

CAOS pag.144

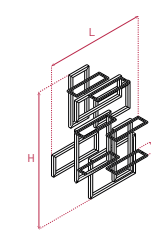

Bronzo Bronze
Nero Black

TOWER S pag.154

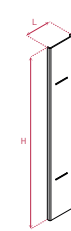

Ghisa Cast iron

GIOSTRA-C pag.74

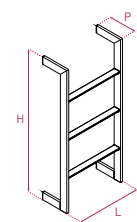

Bianco White
Ghisa Cast iron
Titanio Titanium
Bronzo Bronze
Nero Black

GIOSTRA pag.84

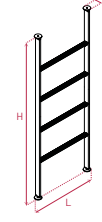

Ghisa Cast iron
Titanio Titanium
Nero Black

IO pag.94

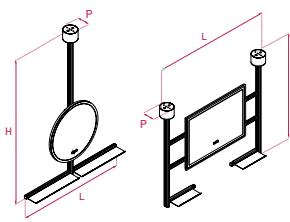

Titanio Titanium
Bronzo Bronze
Nero Black

KUBI pag.164

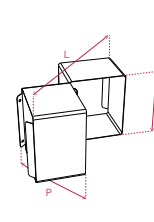

Ghiaccio Ice
Rame Copper
Nero Black
Verde giungla Jungle green
Zirconio Zirconium

JOIN pag.174

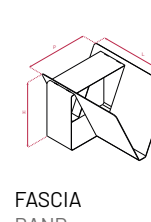

FASCIA BAND



Ghiaccio Ice
Rame Copper
Nero Black
Verde giungla Jungle green
Zirconio Zirconium

BASAMENTO BASE



Ghiaccio Ice
Nero Black

IO-L pag.104

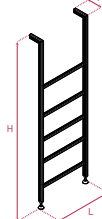

Titanio Titanium
Bronzo Bronze
Nero Black

SHELL pag.114

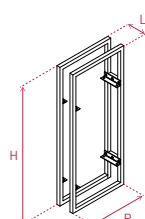

Bianco White
Antracite Anthracite
Bronzo Bronze
Nero Black

OUTLINE pag.124

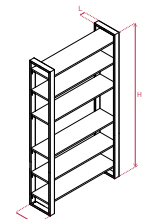

Bianco White
Titanio Titanium
Bronzo Bronze
Nero Black

MATERIALI E FINITURE

MATERIALS AND FINISHES

METALLO / METAL

Finiture strutture e mensole

Structures and shelves finishes



Bianco
White

Ghisa
Cast iron

Titanio
Titanium

Antracite
Anthracite

Bronzo
Bronze

Nero
Black

Finitura Kubi e Join

Kubi and Join finishes



Ghiaccio
Ice

Rame
Copper

Nero
Black

Zirconio
Zirconium

Verde giungla
Jungle green

LEGNO / WOOD

Finiture mensole

Shelves finishes

Legno impiallacciato/Veneered wood

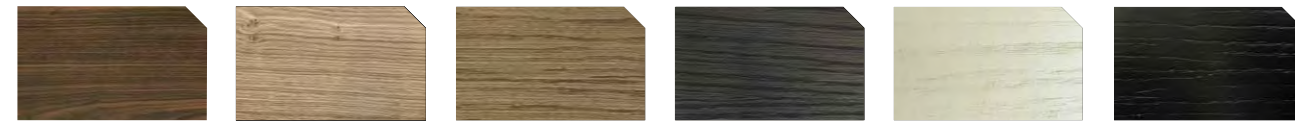

Noce canaletto
Canaletto walnut

Rovere spaccato
Split durmast

Rovere dove
Dove durmast

Rovere dark
Dark durmast

Frassino bianco
White ash

Frassino nero
Black ash

Legno laccato/Lacquered wood



Nero opaco
Matte black

Bianco opaco
Matte white

Grigio opaco
Matte grey

Legno melaminico/Melamine wood

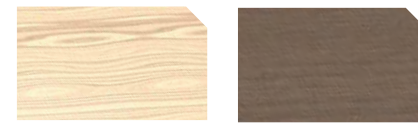

Rovere ortisei
Ortisei durmast

Noce tundra
Tundra walnut

VETRO / GLASS

Finiture mensola Vertical Line, Giostra-L e Giostra-C

Vertical Line, Giostra-L and Giostra-C shelf finishes

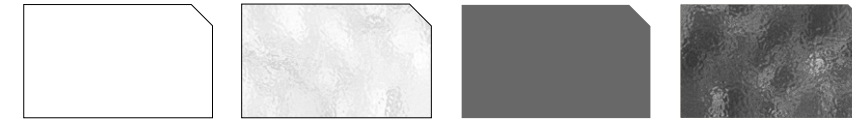

Extra light
Extra light

Extra light ricotto
Annealed extra light

Fumé
Fumé

Fumé ricotto
Annealed fumé

PLASTICA / PLASTIC

Colori Super Chair

Super Chair colors



Bianco
White

Grigio
Grey

Nero
Black

Amaranto
Amaranth

Senape
Mustard

Cuoio
Leather

Blu
Blue

Finiture portarotolo, portaposate, portaspesie e portabarattoli linea Giostra

Giostra roll holder, cutlery holder, spices holder, jars holder finishes



Ghisa
Cast iron

Nero
Black

Bianco
White

Vulcano
Volcan

Giallo ambra
Amber

Salvia
Sage

Conchiglia
Shell



Grigio traffico
Traffic grey

Tortora
Dove