

# THE SURFACE TREATMENT OF METALS

The method of "surface treatment" adopted today is not only influenced by the finish required but it is conditioned to a large extent by the cost of production.

Many factors have changed the art of polishing into a technology of its own: the variety and complexity of the items to be finished, the constant design improvements to automatic polishing machines together with the use of new material to manufacture modern polishing mops and abrasive compositions, as the fruit of modern and continuous research. All have resulted in the modern high-speed buffs becoming nothing less than precision tools.

It is extremely important adopting the correct compound, the right type of mop used at exactly the correct speed for every specific application: then improved finishes can be obtained, output can be increased, costs can be cut and the working cycles simplified. Personal experience counts a lot in this and we wish to offer you the help and assistance in your trials and experiments.



# ABRASIVE COMPOUNDS

## MATERIALS

- **natural abrasives** (natural or calcinated "tripoli"; quartz; pumice; etc.): for traditional yellow, red, black, maroon or grey compounds; specially suitable on brass and alloys in general.

- **synthetic abrasives** (white aluminium oxide; pink-brown or pink corundum): for white, green, blue compounds, all highly abrasive and with elevated finishing capacity on stainless steel and ferrous metals.

## TYPES AND PACKAGES

### Liquid Compounds

The liquid abrasive compounds, made up from an emulsion of various greasy substances, which hold in suspension the abrasive powders, are intended to use almost exclusively for polishing operations on automatic or semi-automatic machines. Liquid compounds allow to adopt a centralized feeding equipment with consequent saving and decrease of time to set up.

The compound is fed through spray guns, either low-pressure or high-pressure type.

The use of synthetic abrasives (aluminium oxide or corundum) produces compounds that are highly abrasives and capable to give a bright finish too. They also adhere well to the mops and have good lubricating features, so as to cool the workpiece and reduce mops wearing.

The physical properties of liquid compounds are stable in normal conditions of use and storage. Possible sedimentation can appear after approx 12 months from the date of production. In order to recover the original viscosity, it could be enough to mix the emulsion for a few minutes. Anyway, our technical staff is at disposal for any controls and advices in case of need.

The choice of one compound rather than another depends on many factors such as the type of mop, type of machine, metal quality, shape of the piece, working time, number of passes, etc.; therefore there are no general rules to follow to the letter.

Our descriptions and suggestions are in general terms: only practical trials can determine the most suitable type.

The liquid compound is packed:

- in cartons of Kg. 25
- in metal pails and drums from Kg. 30 to Kg. 275-285
- in plastic tank of Kg. 1.100-1.300



## Solid Compounds

The solid abrasive compounds, made up from various greasy substances with the addition of abrasive powders, are suitable for polishing operations either with traditional manual polishing units and with automatic or semi-automatic machines.

For manual use each bar of compound is protected by waxed paper; for use with mechanical feeders, each bar is made with the required sizes.

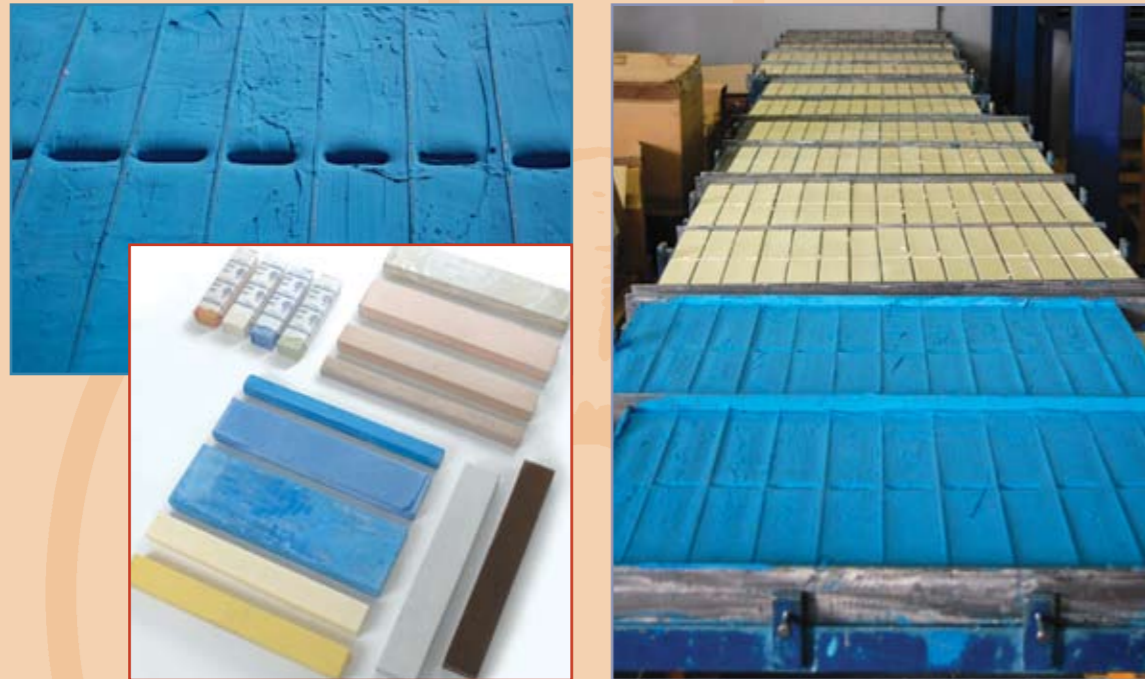

Solid compounds - yellow, red, brown, grey and black types - contain natural abrasives (natural or calcined tripoli, quartz, pumice, emery, etc.) and are particularly suitable on brass and other alloys.

The use of synthetic abrasives (aluminium oxide and corundum) for the white, green, blue and pink types, allows to get highly abrasive compounds, able to produce a fine finishing too.

The physical properties of solid compounds are stable in normal conditions of use and storage up to approx 24 months from the date of production.

The choice of one compound rather than another, depends on many factors such as the type of mop, type of machine, metal quality, shape of workpiece, working time, number of passes, etc.; therefore there are no general rules to follow to the letter. Our descriptions and suggestions are in general terms: only practical trials can determine the most suitable type.

The solid compound looks in bars with standard sizes:

- manual sizes: mm. 60x40x250

- sizes suitable for automatic feeding: mm. 60-70-80-100-120-150x40x500 (other sizes can be realized at request).

In the end, bars are packed in cartons of Kg. 20-30.

For particular requirements, special types of compound can be made up, having non standard characteristics and dimensions.

## LIQUID ABRASIVE COMPOUNDS



### 3536 AP/58 TC

to pre-polish and polish: all metals; in particular suitable for external parts of pots, cutlery, aluminium profiles

with sisal and sisal+cotton buffs, natural and impregnated  
to satin-finishing: in particular aluminium and alloys  
with sisal and tampico buffs



### 3555 AP/46 C

to pre-polish and polish: aluminium, stainless steel, ferrous metals;  
specific for cutlery (ribs)

with sisal and sisal+cotton buffs with or without impregnation, with tampico brushes, with steel wire brushes



### 3520 AP/20

to polish: all metals; in particular suitable for external parts of pots, cutlery, aluminium profiles and brass pieces

with sisal and sisal+cotton buffs, natural and impregnated  
to satin-finishing: aluminium and alloys  
with sisal and tampico buffs



### 3521 AP/51 C

to polish: all metals; in particular suitable for external parts of pots, pots covers, trays, aluminium profiles

with sisal and sisal+cotton buffs, natural and impregnated, with steel wire brushes



### 3522 AP/51 FE

to polish: aluminium, zamac, brass - fire edition -

with sisal and sisal+cotton buffs, natural and impregnated



### 3528 STEEL/70 C

to polish: stainless steel; in particular suitable for internal parts of pots

with sisal+cotton buffs and cotton buffs



### 3539 AP/31 C

to polish: all metals; in particular suitable for internal and external parts of pots, aluminium profiles, taps and faucets, castings

with sisal and sisal+cotton buffs, natural and impregnated, with steel wire brushes



### 3545 AP/31 F

to polish: stainless steel and brass; suitable for lids and trays

with sisal and sisal+cotton buffs, natural and impregnated



### 3530 AIR/ROSE 4

to polish and bright (semi-bright finish): aluminium, zamac, brass; suitable for aluminium profiles, taps and faucets, brass fittings, aluminium pots and lids

with sisal and sisal+cotton buffs, with natural cotton buffs and treated cotton buffs

## SOLID ABRASIVE COMPOUNDS

### 3554 LAV/2 INOX

to satin finish: stainless steel; specific product for sinks  
with sisal and tampico buffs

### 3532 LUX BLU

to bright finish aluminium; recommended on aluminium profiles  
(the product has a fair cutting power)  
with treated cotton buffs (type Royal Blue) and natural cotton buffs

### 3533 LUX ROSA

to bright and mirror finish: all metals; in particular suitable for aluminium profiles and brass pieces  
with treated cotton buffs and natural cotton buffs

### 3550 SILVER LUX/2

to bright and mirror finish: all metals; in particular suitable for external parts of pots, lids, aluminium profiles and brass pieces  
with natural cotton buffs

### 3551 SILVER LUX/EC

to bright and mirror finish: all metals; in particular suitable for external parts of pots and cutlery  
with treated cotton buffs and natural cotton buffs

### 3564 SILVER LUX/4

to bright and mirror finish stainless steel, ferrous metals; in particular suitable for sinks  
with treated cotton buffs and natural cotton buffs

### 3511 SILVER LUX/11

to mirror finish: all metals; in particular suitable for pots and pans, cutlery and brass pieces  
with treated cotton buffs and natural cotton buffs

### 3674 BROWN/ROBOT 2004

to polish and bright finish with robot units: recommended on brass pieces (taps and faucets); in particular suitable for high climate temperatures  
available in DRY version (i.e. the compound is drier than normal version)  
with sisal+cotton buffs, natural and impregnated; with natural and treated cotton buffs semi-bright finish can be achieved

### 3675 BROWN/ROBOT 2006

to polish and bright finish with robot units: recommended on brass pieces (taps and faucets); in particular suitable for high climate temperatures  
2006 version is more cutting than 2004  
with sisal+cotton buffs, natural and impregnated; with natural and treated cotton buffs semi-bright finish can be achieved

### 3612 GIALLA SUPER

to polish and bright finish: aluminium, zamac and brass  
with sisal+cotton buffs and cotton buffs

### 3653 WHITE ROBOT 97

to pre-polish and polish: aluminium, zamac, brass and all metals in general  
with sisal and sisal+cotton buffs, with natural and treated cotton buffs

### 3624 BIANCA/S 181

to bright finish: brass  
with cotton buffs

### 3641 ROSA NEW BRASS

to bright and mirror finish: zamac and in particular aluminium and brass  
with cotton buffs

### 3640 P/707 LEOPARD

to polish and bright finish at the same time: aluminium, zamac, brass.  
Very fine product with cutting abrasive power; it gives a very homogeneous finish, allowing a deep final chromium plating  
with cotton buffs



**3647 WHITE IRON 41**

to pre-polish and polish: all metals  
with sisal and sisal+cotton buffs, with steel wire brushes

**3615 BIANCA MILLENIUM**

to polish: all metals in particular stainless steel and brass; suitable for internal and external parts of sinks, tableware  
with sisal and sisal+cotton buffs, natural and with impregnation, extremely good with steel wire brushes too

**3631 BIANCA INOX/2006**

to polish and bright finish: all metals in particular iron  
with sisal and sisal+cotton buffs, natural and with impregnation, with cotton buffs and with steel wire brushes

**3638 P/578 TC**

to polish and bright finish: all metals, in particular stainless steel  
with sisal and sisal+cotton buffs, natural and with impregnation, with cotton buffs

**3646 BLU INOX 38**

to polish and bright finish: all metals, recommended on aluminium; fine cutting  
with sisal and sisal+cotton buffs, natural and with impregnation, with cotton buffs

**3657 HERCULES**

to polish and bright finish all metals, particularly suitable for brass, castings and stainless steel  
with sisal+cotton buffs, natural and with impregnation, with steel wire brushes

**3632 ROSA/88**

to polish: all metals, in particular brass  
with sisal buffs natural and with impregnation, with sisal+cotton buffs with impregnation, with steel wire brushes

**3611 NERA INOX**

to polish and bright finish: stainless steel  
with sisal and sisal+cotton buffs, natural and with impregnation

**3636 AZZURRA/N**

to bright and mirror finish: all metals, in particular iron and zamac  
with natural and treated cotton buffs, with woollen cloth buffs

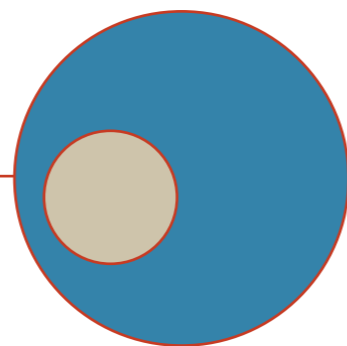

# RPH®

**3645 AZZURRA/94**

to bright and mirror finish: all metals, in particular iron, zamac and stainless steel  
with natural and treated cotton buffs, with woollen cloth buffs

**3662 MOONLIGHT**

to mirror finish all metals, particularly suitable for brass and alloys (fashion accessories):  
right for 3rd operation (1st polishing; 2nd bright finishing; 3rd mirror finishing)  
with cotton buffs

**3668 BLUSTAR**

to mirror finish all metals  
with cotton buffs

**3640 P/707 LEOPARD**

to polish and bright finish at the same time: aluminium, zamac, brass.  
Very fine product with cutting abrasive power; it gives a very homogeneous finish,  
allowing a deep final chromium plating  
with cotton buffs

## VARIOUS COMPOUNDS

realized for special applications and operations

**3724 TALLOW solid compound**

Lubrificants for abrasive belts and flap wheels of abrasive cloth

**3741 TALLOW liquid compound**

Lubrificants for abrasive belts and flap wheels of abrasive cloth

**3728 solid abrasive compound BIANCA S/105****3746 solid abrasive compound BIANCA PLAST**

to bright finish polyester and plastic

**3715 solid abrasive compound BIANCA/SM**

to bright finish marble

**3740 solid abrasive compound GRANITO**

to bright finish granite

**3753 solid abrasive compound P 286/S****3755 solid abrasive compound CRIS 190/S**

to bright finish polyurethane shoes soles

**3729 "in cold" paste**

to stick the abrasive powder on felt and sisal items

**3718 "FIORE/S" paste**

Cleaning paste for hands to remove oil, grease, paint, etc. Package: 5 Kg. cans.

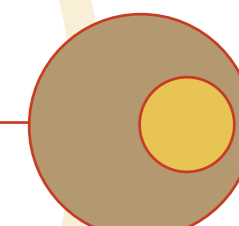

# SPRAYING AND FEEDING SYSTEM FOR LIQUID AND SOLID ABRASIVE COMPOUNDS

## LIQUID ABRASIVE COMPOUNDS

The best way of using liquid abrasive compounds is that of spraying them with low or high-pressure guns, by means of a centralized system, so as to obtain a light, regular and uniform supply.

The system types are two:

### 1) with pressure tank, from 50 to 100 litres;

Lay-out:

- Pressure tank with reducer, 50 litres (max pressure 8 atm)

or

- Pressure tank with reducer, 100 litres (max pressure 6 atm)

- Steel filter 1"

- Low pressure spray gun (2 models available) and related electro-valve

or

- High pressure spray gun (3 models available) and related electro-valve

### 2) with tank "siletto" (a pump is fixed on it)

Lay-out:

- "Siletto" (2 models available): polythene tank with strong steel frame

- Membrane pump

or

- Piston pump

- Steel filter 1,5"

- Low pressure spray gun (2 models available) and related electro-valve

or

- High pressure spray gun (3 models available) and related electro-valve

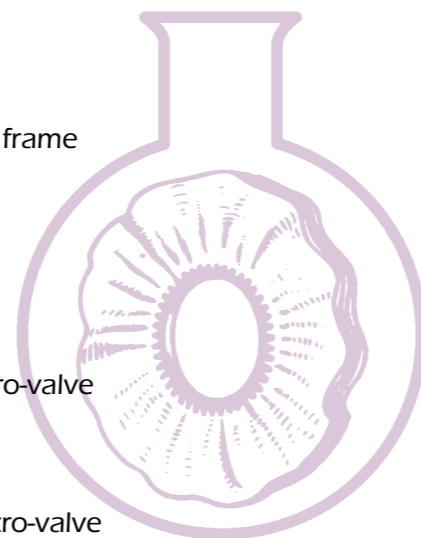

RPH®

## SOLID ABRASIVE COMPOUNDS

The supply of solid abrasive compound is made by means of a pneumatic feeder, mod. COSMEC, applied on both manual and automatic polishing machines.

The feeder carries out the feeding on to rotating mops in such a way to obtain a perfect dosing, a correct pressure on the mop, less waste of unused compound and, in case of manual machine, it allows the operator to have both hands free.

The feeding control can be managed by a foot pedal or, as usually done on automatic polishing machines, by means of an electro-valve and timer, to obtain automatic and programmable feeding.

The feeding is effected by a double action pneumatic

cylinder, that carries out the following operations:

A) lowering to the mop

B) slow return to position (to prevent the compound bar from a continuous contact with the mop).

Both the feeding speed (A) and the return (B) are adjustable by means of the valves placed on the top of the feeder, at the inlet of the cylinder.

By adjusting the cylinder stroke we can dose up the quantity of the compound to be fed in each single lowering. Also the feeding pressure can be adjusted.

The feeder can employ compound bars having the max dimensions of 160 mm., length 500 mm., height 50 mm.



Cosmec  
feeder

# COMPONENTS

- art. 3850 Pressure tank with reducer, 50 litres (max pressure 8 atm)
- art. 3851 Pressure tank with reducer, 100 litres (max pressure 6 atm)
- art. 3824A Tank "Siletto" mod. RPH/600 containing approx Kg. 800 of compound
- art. 3824B Tank "Siletto" mod. RPH/1000 containing approx Kg. 1300-1500 of compound



Pressure tank



Tank "Siletto"



Pump and Filter assembly on the tank "Siletto"

- art. 3848 Steel filter 1", for pressure tank
- art. 3849 Steel filter 1,5", for tank "siletto"



Filters

- art. 3819 Membrane pump mod. PM/500 - SP (maximum power 10 atm) (enough to feed a pipe of length approx 25-30 metres, with 8-10 guns)
- art. 3825 Piston pneumatic pump mod. GRV R2B (maximum power 12 atm) (enough to feed a pipe of length approx 60-70 metres, with 15-20 guns)



Pump mod. PM/500 - SP

- art. 3862 High pressure gun mod. AP/862
- art. 3866 High pressure gun mod. AP/866
- art. 3875 High pressure gun mod. AP/868



mod. AP862



mod. AP866



mod. AP868

- art. 3859 Low pressure gun mod. BP/95
- art. 3857 Low pressure gun mod. RPH E40M (specific for cutlery machines)



mod. BP/95

- art. 3821 Nozzles, various degrees
- art. 3887 Electro-valve for high pressure gun
- art. 3842 Electro-valve for low pressure gun
- art. 3873 Manometre for compound pressure control
- art. 3822 Adapter for guns
- art. 3863 Solid compound feeder mod. Cosmec
- art. 3865 Foot pedal feeding control



Manometer



Adapter

Remarks: We can supply all spare parts and instruction manuals for guns and pumps.

# TECHNICAL INFORMATION

The abrasive compound must leave the tank at 4-5 atm; to operate low pressure guns use 5-6 atm; for high pressure guns follow the manufacturer's instructions.

The **low pressure** gun sprays the compound at a force equal to that of the air supply to which it is connected (5-6 atm); the **high pressure** gun, which incorporates a multiplier, sprays the compound at a pressure 20-30 times superior than that of the air supply.

High pressure gun is necessary when the compound sprayed by a normal pressure gun is wasted by the polishing mops centrifugal force.

High pressure gun saves a lot of compound and due to the different angles of the nozzles (40°, 65°, 90° and 120° can be chosen) one single gun can spray the polishing wheel from 2 to 50 cm. wide.

The choice between the two types depends on the different purchase prices and the specific requirements of the work to be done.

The use of an automatic distribution system will give the following advantages:

- the siletto is not just a package for the compound, but a basic component of the equipment, where you pour the liquid compound from the standard packages, which are 25 Kg. carton boxes, 30 Kg. metal pails, 275-285 Kg. metal drums.
- the filling up operation of the empty tanks is carried out without stopping the polishing machine, since the siletto is not a pressure tank;
- the filling up operation is easy and speedy;
- a long autonomy after the filling up;
- more space and order in the polishing department.

# BUFFS - MOPS - WHEELS FOR POLISHING AND BRIGHT FINISHING

## MATERIALS AND APPLICATIONS

COTTON CLOTH WOOLLEN CLOTH	BRIGHT, MIRROR FINISH	ALL METALS ALUMINIUM AND ALLOYS
RODIFLEX (ABRASIVE SPONGE)	SATIN FINISH	STAINLESS STEEL ALUMINIUM
TAMPICO FIBRE PLAITED SISAL	BRIGHT FINISH, SATIN FINISH BRIGHT FINISH, SATIN FINISH	STAINLESS STEEL ALL METALS
SISAL + COTTON SISAL	PRE-POLISH AND POLISH PRE-POLISH AND POLISH	ALL METALS ALL METALS
STEEL WIRE	PRE-POLISH, SATIN FINISH	STAINLESS STEEL
ABRASIVE CLOTH	GRINDING (WET OR DRY)	FERROUS METALS AND NON FERROUS METALS

## TYPES

- **simple sections buffs, or simple sections buffs with central stitching:** traditional buffs generally used on hand held spindles, manual machines. They are made up of various qualities of cotton (also with "stock material"), of woollen cloth, of Rodiflex. They can be prepared in "packs" with stitching at the centre.
- **simple sections buffs with stitchings:** traditional big diameter buffs for robot, with stitchings at request.
- **ventilated buffs:** for all polishing, bright/mirror finish and satin finish operations of flat and shaped pieces on manual and automatic machines. They can be made up of natural and treated cotton cloth, woollen cloth, Rodiflex, sisal+cotton and sisal cloth with or without impregnations. Ventilated buffs made up of thin sisal cloth produce a semi-bright finish. If they are made up with sisal lined with cotton (with many stitches to strengthen), they have an higher retention of the compound. By modifying the compound used, they are suitable for any type of material: stainless steel, aluminium, brass, alloys, plastic, etc.

The hardness of the ventilated buffs is controlled by:

- **internal bore**
- **number of layers:** for cotton buffs 12, 16, 20, 24  
for sisal+cotton buffs 2, 4, 6  
for sisal buffs 4, 6, 8
- **number of pleats**
- **type of ventilation:** PV light ventilation  
NV normal ventilation  
MV heavy ventilation

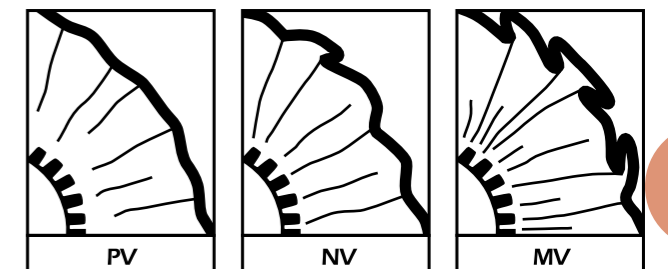

- **pleated buffs:** for all polishing and bright finishing operations, suitable for "immersion" polishing of shaped and small pieces. They can be made up of natural and treated cotton cloth, sisal and sisal+cotton with or without impregnation. In this case too, by modifying the type of compound, they are suitable for all metals: stainless steel, aluminium, brass, alloys, plastic, etc.

Each single layer is folded in a "Z" shape (pleated - see the picture below) and then arranged around the centre:

- in "standard" style: the buff is more rigid
- in "spiral" way: the buff is more flexible

A particular making consists of a mini-pleated structure (folded in very small "Z" shape) that makes the buffs suitable for "immersion" polishing of small work pieces (handles, tap knobs, etc.): the buff is named art. 1086 mini-pleated made up of cotton type MA.

There are two types of pleated buffs:

- a) **with metal rings (see below):** external diameter 250-500 mm. standard and spiral
- b) **with big diameter:** external diameter 700-960-1600 mm. spiral, with cardboard reduction and soon metal rings



- **stitched cotton buffs:** simple sections buffs with spiral stitchings, width from 8 to 20 mm. For manual and automatic polishing machines.

- **stitched sisal buffs:** for rough cutting and heavy removal rates. For manual and automatic polishing operations. They can be made up of sisal or sisal+cotton with or without impregnation.

- **stitched "in segments":** in spiral form with average width of 5-20 mm. The sisal cloth is cut in segments, i.e. in triangles, with the fibres arranged at 45° to reduce fraying to a minimum and to ensure uniform wear. They can be impregnated (details at page 22).
- **stitched "all bias weave":** they are suitable for all metals that call for heavy removals and roughing operations. They are normally submitted to impregnations (details at page 22).

- **corrugated buffs:** for roughing works and polishing operations (stainless steel, iron, chrome). Thanks to this particular corrugation of the cloth (sisal+cotton with or without impregnation, natural and treated cotton) one obtains a very aggressive effect without however overheating the work piece. Through appropriate impregnations, the hardness and life are improved (details at page 22).

Corrugated buffs are recommended when it is necessary to work with a single wheel, which does not open out.

- **plaited sisal buffs:** the main features of these buffs are the extreme flexibility and softness, which make possible the polishing of complicated shapes. Various impregnations can be applied to increase life-time (details at page 22).

## ASSEMBLY

- the 45° cloth weave cut on the circumference of the buffs minimises wear and dust production.
- the flexibility or stiffness of the mop is conditioned by:
  - number of layers
  - sizes of folds or corrugations
  - relation between the internal bore and the external bore
  - width of the stitching
- the centre can be either a removable metal ring (strongly suggested) or a fixed centre, made of cardboard or plastic.
- the buffs are manufactured with high attention and care to guarantee a correct balance.

## SAFETY INFORMATION

Polishing buffs and mops spin on machines at high speeds.

It is necessary to protect the workers and operators making frequent check and adopting some precautions:

- all buffs should run on stable non vibrating spindles;
- the side mounting flanges of the buffs on the spindles must have the correct sizes (up to 40% of the buff should be covered, the metal ring must always be completely covered).
- safety hoods on the machinery should cover the buffs as they are running.
- the operator should wear the personal protection: head-protection, safety glasses and gloves. Polishing buffs can break up and fly apart, when incorrectly mounted and used.

Product Safety Data Sheet are available on request.

### TABLE OF PERIPHERAL SPEED IN METERS/SECOND

RPM	outside diameter in mm.															
	100	125	150	175	200	250	300	350	400	450	500	600	750	960	1000	1600
300													11,7	15,0	15,7	25,1
400													15,6	20,0	20,9	33,5
450													17,6	22,5	23,5	37,6
500													19,5	25,0	26,1	41,8
550													21,5	27,5	28,7	46,0
600								11,0	12,6	14,1	15,7	18,8	23,4	30,0	31,4	50,2
700													27,4	35,0	36,6	-
800						10,5	12,6	14,6	16,7	18,8	20,9	25,1	31,3	40,0	41,9	-
900													35,2	45,0	47,1	-
1000													39,1	50,0	52,4	-
1100													43,1	-	-	-
1200													46,9	-	-	-
1300													50,8	-	-	-
1400			11,0	12,8	14,7	18,4	22,0	25,6	29,2	33,0	36,6	44,0				
1600			12,6	14,7	16,8	20,9	25,1	29,3	33,4	37,6	41,9	50,2				
1800		12	14,2	16,5	18,9	23,5	28,2	33,0	37,6	42,4	47,1	56,4				
2000	10	13	15,7	18,4	21,0	26,1	31,4	36,4	41,8	47,1	52,4					
2200	12	14	17,2	20,0	23,0	28,8	34,5	40,3	46,0	51,8	57,6					
2400	13	15	19,0	22,0	25,1	31,4	37,6	44,0	50,0	56,5						
2600	14	17	20,4	23,8	27,2	34,0	40,8	47,6	53,2							
2800	15	18	22,0	25,6	29,3	36,6	43,9	51,3	58,4							
3000	16	20	23,8	27,5	31,4	39,2	47,0	55,0								



# IMPREGNATIONS

The impregnation of the buffs increases their wear resistance, being them made of sisal fibre, tampico or cotton; it improves the compounds adhesion and enhances the cutting effects. The result is a longer life of the buff. The choice of the suitable impregnation depends on the application, on the customer requirement and our experience too.

**All our impregnations are worked out in respect for the environment.**

## IMPREGNATIONS FOR SISAL BUFFS

impregnation code	colour	application	density
G/2	<b>YELLOW</b>	all metals	rigid and dry
V/3	<b>GREEN</b>	all metals	medium-rigid
B/50	<b>ORANGE</b>	all metals	dry and not very flexible
B/30	<b>GREY</b>	all metals	dry and flexible
VIOLA	<b>VIOLET</b>	all metals	dry and medium-flexible
B	<b>BLUE</b>	all metals	dry and very flexible
B/L	<b>LIGHT BLUE</b>	all metals	dry and extremely flexible
RV/100 e RV/200	<b>RED</b>	all metals	used to harden stitched sisal mops; the number that follows the mark RV indicates the hardness degree.

## IMPREGNATIONS FOR SISAL AND TAMPICO BUFFS

impregnation	colour	application	density
TP	<b>BROWN</b>	stainless steel	soft and sticky
TPLL	<b>LIGHT BROWN</b>	stainless steel	very soft, sticky and flexible

## TREATMENTS FOR COTTON BUFFS

treatment	colour	application	density
Golden GG	<b>GOLDEN YELLOW</b>	steel, aluminium, brass, alloys	rigid, hard, dry and very resistant
Golden GB	<b>WHITE</b>	steel, aluminium, brass, alloys	semi-rigid, dry and resistant
Royal Blu	<b>BLUE</b>	steel, aluminium, brass, alloys	flexible and resistant
Nap Verde	<b>GREEN</b>	steel, aluminium, brass, alloys	medium-rigid on soft cloth
Red	<b>RED</b>	steel, aluminium, brass, alloys	flexible and resistant, on cloth of high quality

# COTTON BUFFS

The cotton buffs are made up of different qualities of cloth, both natural and treated (with specific resins).

Depending on the cloth quality and the type of abrasive compound used, polish, bright and mirror finishes of the metal surface can be achieved.

The natural cotton cloth combined with a brightening compound is particularly suitable for the mirror finish.

The natural cotton cloth can be treated, becoming more resistant, cutting and lasting.

Special care and attention are addressed to the processing operation of the buffs to guarantee an appropriate balance.

## RPH COTTON CLOTHS

- **MA EXTRA**  
extra quality  
to bright and mirror finish all metals
- **MA**  
superior quality  
to bright and mirror finish all metals
- **MC**  
standard quality, "heavy" cloth  
to polish and bright finish on a single operation
- **MB**  
medium quality  
to pre-bright finish
- **NF**  
standard quality  
to bright finish pots and lids, brass and alloy pieces
- **FL**  
soft cotton quality  
to high mirror finish
- **FM**  
soft cotton quality  
to high mirror finish
- **GOLDEN GG**  
treated cotton, yellow, rigid and very resistant  
for stainless steel, aluminium, brass and alloys
- **GOLDEN BIANCO**  
treated cotton, white, flexible and resistant  
for stainless steel, aluminium, brass and alloys
- **ROYAL BLU**  
treated cotton, blue, flexible and resistant  
for stainless steel, aluminium, brass and alloys
- **NAP VERDE**  
treated medium quality cotton, green, flexible  
for stainless steel, aluminium, brass and alloys
- **RED**  
treated high-quality cotton, red, flexible and resistant  
for stainless steel, aluminium, brass and alloys

# SIMPLE SECTIONS AND STITCHED BUFFS

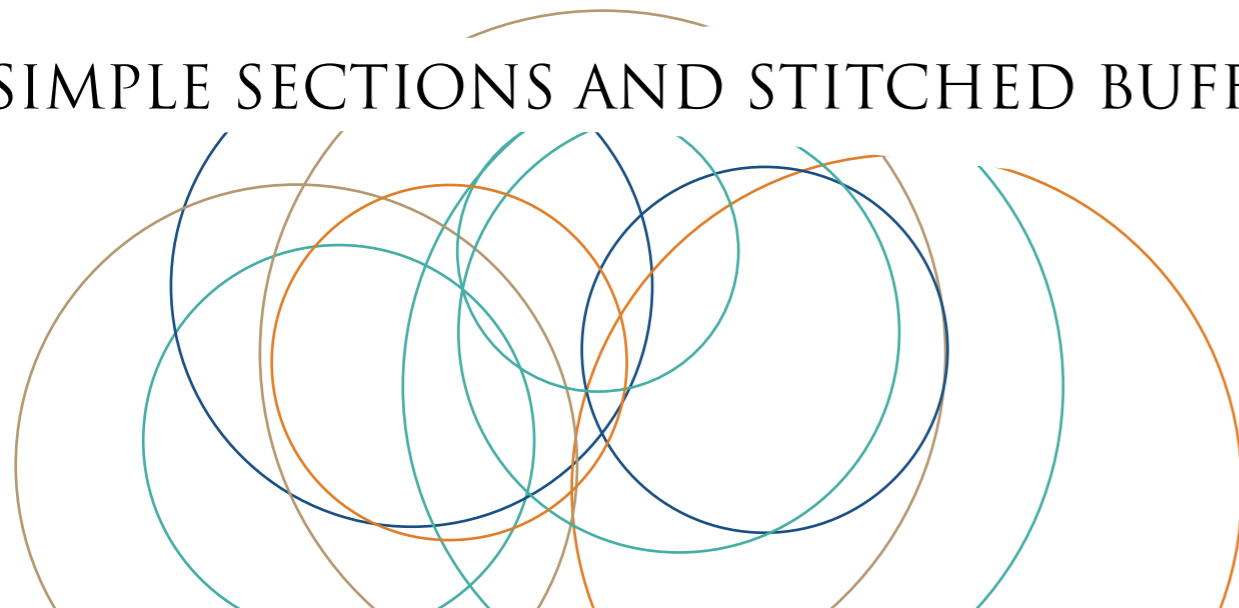

Simple sections buffs

## Simple sections buffs

- **external Ø:** 80-500 mm.
- **internal bore:** 15-80 mm.
- **assembly:** simple sections or in "packs" with sewing at the centre
- **cloth types:** various qualities of cotton, white and coloured shirt-cloth, various stock cloth
- **applications:** manual and automatic polish and bright finish of all metals



with treated cotton Royal Blu



with treated cotton Golden GG

## Stitched cotton buffs

- **external Ø:** 80-500 mm.
- **internal bore:** 15-80 mm.
- **assembly:** 8-20 mm. width spiral stitchings
- **cloth types:** various qualities of cotton, white and coloured shirt-cloth, various stock cloth
- **applications:** manual and automatic polish of all metals



art. 1056

## Big diameter buffs for robot

- **external Ø:** 600-1600 mm.
- **internal bore:** 40-50-60 mm., at request
- **stitchings:** standard 50 mm.  
40, 30, 20 mm., etc. are possible
- **cloth types:** cotton type MA and NF
- **article reference:** **1056** type MA  
**1051** type NF
- **applications:** traditional big diameter buffs for robot; polish and bright finish of all metals



art. 2041



art. 2050

- **cloth types:** various treated cotton qualities
- **article reference:** **2041** type GOLDEN GG (yellow)  
**2047** type GOLDEN BIANCO (white)  
**2048** type ROYAL BLU (blue)  
**2009** type NAP VERDE (green)  
special buffs manufactured by alternating cotton section type MA with different treated cotton sections:  
**2050** type NAP VERDE + MA  
**2051** type NAP VERDE + MA + ROYAL BLU  
**2052** type ROYAL BLU + MA
- **applications:** traditional big diameter buffs for robot; polish and bright finish of all metals

# VENTILATED BUFFS



art. 1002



art. 1004



art. 2004



art. 2002



art. 2005



art. 2011



art. 2011 detail

- external Ø: 250-600 mm.
- internal bore: 55-230 mm.
- layers: 12-16-20-24
- assembly: PV = light ventilation  
NV = normal ventilation  
MV = heavy ventilation
- cloth types: all cotton cloth types, both natural and treated (see details at page 23)

- articles reference: 1005 type MA EXTRA  
1002 type MA  
1004 type MC  
1003 type MB  
1001 type NF  
1021 type FL  
1010 type FM

- applications: high mirror finish  
high mirror finish and bright finish  
bright and mirror finishing  
bright and mirror finishing  
high mirror finish  
high mirror finish  
high mirror finish

- articles reference: 2005 type GOLDEN GG  
2002 type GOLDEN BIANCO  
2004 type ROYAL BLU

- 2023 type NAP VERDE  
2011 type MULTICOLOUR

- standard dimensions:

- applications: for heavy works and roughing  
for all kinds of work  
for polishing and semi-brightening of all metals, in particular aluminium and stainless steel  
for all kinds of work  
for polishing and semi-brightening  
special buff manufactured by alternating cotton section type MA with treated cotton section type ROYAL BLU and NAP VERDE

- Ø 250 x 55-80 mm.
- Ø 300 x 55-80-110 mm.
- Ø 350 x 80-110-130 mm.
- Ø 400 x 80-130-150-180 mm.
- Ø 450-500 x 130-150-180 mm.
- Ø 600 x 180-230 mm.
- We can realize special dimensions at request.

## Ventilated cotton buffs for cutlery

- external Ø: 80-200 mm.
- internal bore: 19/6-20-24/6-25 mm.
- layers: 8-10
- cloth types: all cotton cloth types, both natural and treated (see details at page 23)

- articles reference: 1311 type MA  
1309 type MC  
1336 type MB  
1310 type NF  
1308 type FL  
1337 type FM  
2325 type GOLDEN GG  
2324 type ROYAL BLU  
2333 type NAP VERDE  
2311 type MULTICOLOUR

- applications: for polishing and bright finishing cutlery (spoons, forks, knives, etc.)



Cookware polishing



Rims polishing

# PLEATED BUFFS



Polishing operation on taps/faucets

The pleated cotton buffs are used almost exclusively on automatic machines to polish and bright finish shaped pieces.

Each single layer is folded in a "Z" shape (pleated) and then arranged around the centre in different ways:

- **standard (ST)** = rigid buffs
- **spiral (SP)** = more flexible buffs
- **mini-pleated** = very small "Z" pleats: this special assembly allows the "immersion" polishing of small parts (handles, tap knobs, etc.).  
Mini-pleated buffs are available made up of cotton cloth type MA (art. 1086)

## A) PLEATED BUFFS WITH METAL SEAM

- **external Ø:** 250-700 mm.
- **internal bore:** 50-230 mm.
- **standard layers:** 2x4, 2x6, 2x8, 3x4, 4x4 (variations are possible)
- **cloth types:** natural cotton type MA and NF, treated cotton type Golden GG, Golden Bianco, Royal Blu

- **articles reference:**

- <b>standard pleated</b>	- <b>spiral pleated</b>
<b>1071</b> type MA	<b>1077</b> type MA
<b>1070</b> type NF	<b>1076</b> type NF
<b>2085</b> type GOLDEN GG	<b>2075</b> type GOLDEN GG
<b>2082</b> type GOLDEN BIANCO	<b>2072</b> type GOLDEN BIANCO
<b>2084</b> type ROYAL BLU	<b>2074</b> type ROYAL BLU

- **applications:** for polishing and bright finishing of metals and alloys; for "immersion" polishing of shaped pieces.



art. 1071 ST pleated



art. 2084 ST pleated

## B) SPIRAL PLEATED BIG DIAMETER BUFFS FOR ROBOT

The spiral pleated big diameter buffs have cardboard centre; they are made up of natural and treated cotton cloth.

- **external Ø:** 700-960-1600 mm.
- **internal bore:** at request
- **layers:** 4x3, 4x4, 4x5
- **no. of stitchings:** standard no. 6-30 mm. (variations are possible)
- **articles reference:**
  - 1080** type MA EXTRA
  - 1077** type MA
  - 1076** type NF
  - 1078** type MC
  - 1088** type FL
  - 2075** type GOLDEN GG
  - 2072** type GOLDEN BIANCO
  - 2074** type ROYAL BLU
- **applications:** for robotics polishing and bright finishing of shaped pieces in all metals and alloys

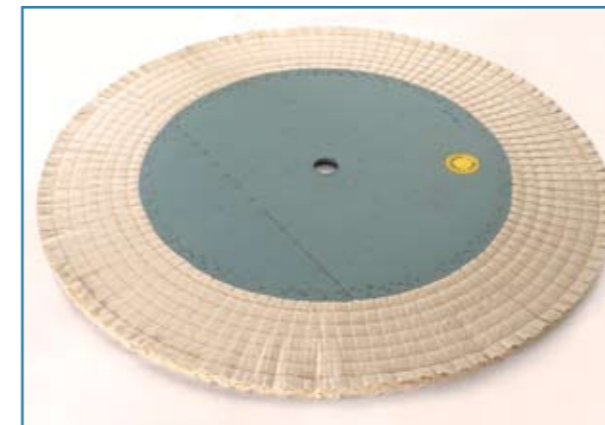

art. 1077 Ø 1600 mm. spiral pleated

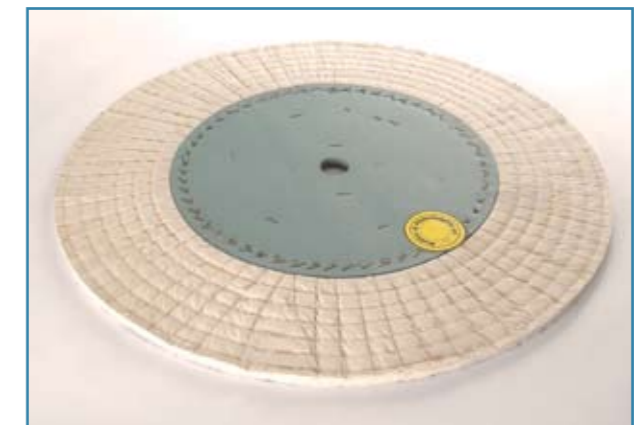

art. 1077 Ø 960 mm. spiral pleated



Handles, taps and faucets

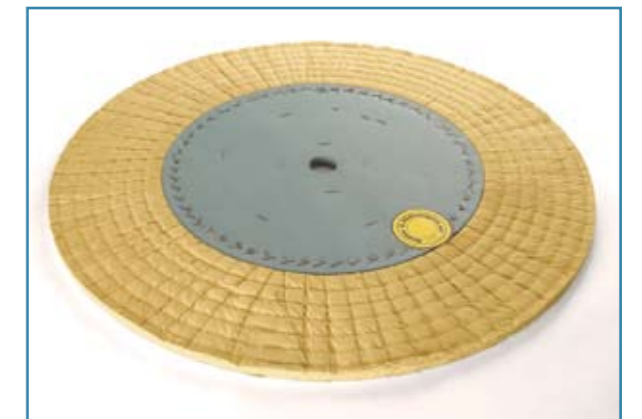

art. 2075 Ø 960 mm. spiral pleated

## CORRUGATED BUFFS



art. 1033



art. 2044



art. 2045

- **standard dimensions:**
    - Ø 250 x 80 mm.
    - Ø 300 x 80-110 mm.
    - Ø 350 x 130 mm.
    - Ø 400 x 130-150-180 mm.
    - Ø 450 x 180 mm.
    - Ø 500-550-600 x 230 mm.
  - **thickness:** 30 mm.
- We can realize special dimensions at request.

- **cloth types:** natural cotton type MA, all treated cotton types

- **articles reference:** 1033 type MA  
2045 type GOLDEN GG  
2042 type GOLDEN BIANCO  
2044 type ROYAL BLU

- **applications:** for polishing and pre-bright finishing of stainless steel, chrome, iron (pots and pans, tableware, tubes and pipes); it is recommended when it is necessary to work with a single wheels which does not open out (example: pots edges).

## WOOLLEN CLOTH BUFFS WOOLLEN CLOTH + COTTON BUFFS FOR ALUMINIUM AND ALLOYS

These buffs are made up with woollen cloth, possibly mixed with cotton cloth, and they are used on both manual and automatic machines for treating aluminium and its alloys. A special grade of finish can be obtained.

### SIMPLE SECTIONS AND STITCHED BUFFS

- **external Ø:** 250-400 mm.
- **internal bore:** 15-80 mm., at request
- **assembly:** simple sections or spirally stitched at 8-10 mm. width
- **articles reference:** 1261 woollen cloth simple sections type (available with diameter inferior to 250 mm.)  
1262 woollen+cotton cloth simple sections type with stitching in the centre (available with diameter inferior to 250 mm.)  
1251 stitched woollen cloth type (available with diameter inferior to 250 mm.)  
1252 stitched woollen+cotton cloth type (available with diameter inferior to 250 mm.)
- **applications:** for bright finishing of aluminium profiles



art. 1251

### VENTILATED BUFFS

- **external Ø:** 250-600 mm.
- **internal bore:** 50-230 mm.
- **layers:** for woollen cloth buffs 4-6-8  
for woollen cloth+cotton buffs 8-12
- **cloth types:** woollen cloth, woollen cloth mixed with cotton cloth type MA
- **assembly:** PV = light ventilation  
NV = normal ventilation  
MV = heavy ventilation
- **articles reference:** 1201 ventilated woollen cloth  
1205 ventilated woollen+MA cotton cloth (the presence of MA cotton cloth increases the resistance, the cutting power and lifetime of buffs)
- **applications:** for bright finishing of aluminium profiles



art. 1205



art. 1201



art. 1205 detail

# RODIFLEX BUFFS AND WHEELS

## MATERIAL

The RODIFLEX synthetic material, with a spongy appearance, is made from nylon fibres and grains of abrasive, by a special method, and gives excellent results in all polishing operations where a reduced metal removal is called for. Thanks to the various grits and different structures, RODIFLEX is the ideal tool to obtain satin finishes on aluminium sections, cutlery, handles, stainless steel sheets, wooden panels and frames.

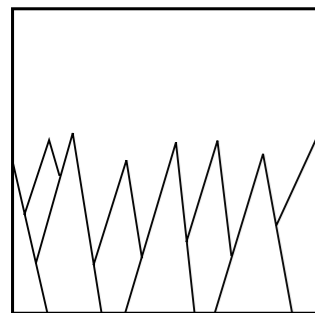

**Abrasive type: Silicon Carbide (SC) structure, colour dark grey**

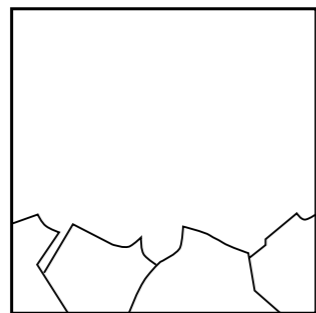

**Abrasive type: Aluminium Oxide (AO) structure, colour red**

## PRESSURE

Only use a slight pressure because the work is done by the abrasive and not by the force exerted by the operator or by the machine. Excessive pressure results in rapid wear and unsatisfactory finish.

## WORKING SPEED

The peripheral speed should be between 15-25 meters per second: any higher speed gives a worse finish and causes excessive wear of the wheel, or even its breaking, and can leave some black traces on the surface.

TYPES OF RODIFLEX					
satin finish	grit	silicon carbide		aluminium oxide	
ultra fine	400-600	SC UF	dark grey		
very fine	320-360	SC VF	dark grey	AO VF	red
fine	220-280	SC F	dark grey	AO F	red
medium	120-180	SC M	dark grey	AO M	red
coarse	80-100			AO C	red

## SIMPLE SECTIONS BUFFS

- external Ø: 100-550 mm.
- internal bore: 10-230 mm.
- assembly: simple sections
- types: all types of Rodiflex in the various grits
- article reference: **1401**
- applications: for satin finishing of aluminium, stainless steel, pewter, wood, using manual or automatic machines



art. 1401 SC

## VENTILATED BUFFS



art. 1407 SC 2 layers



art. 1402 SC 4 layers

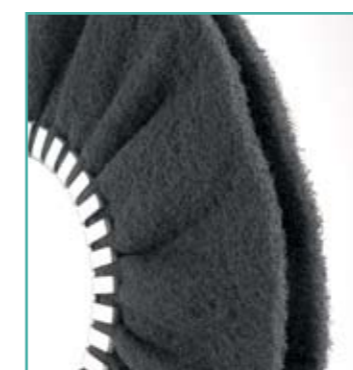

art. 1407



art. 1402

- external Ø: 200-600 mm.
- internal bore: 55-230 mm.
- layers: 2-4
- types: all types of Rodiflex in the various grits
- articles reference: **1407** type with 2 layers, very flexible and useful for treatment of small grooves and falls
- applications: **1402** type with 4 layers, more rigid than 2 layers buffs for satin finishing of aluminium, stainless steel, pewter; they are used on table type machines, transfer machines, rotary table machines; they work without abrasive compounds.

# SPIRAL PLEATED BIG DIAMETER BUFFS FOR ROBOT

These buffs are assembled to a cardboard centre or a metal ring centre. They are made with RODIFLEX type FINE and VERY FINE.

- external Ø: 960 mm.
- internal bore: at request
- layers: 1x2, 1x3
- no. of stitchings: at request
- article reference: **1420**
- applications: for satin finishing of aluminium, stainless steel, etc. on robotics units



art. 1420 AO 1x2 layers



**RPH**<sup>®</sup>

# FLAP WHEELS

- external Ø: 110-450 mm.
- internal bore: 25-300 mm.
- length: 10-2000 mm.
- density: **MD** = medium; **HD** = high; **HDE** = very high
- types: all types of Rodiflex in the various grits
- article reference: **1404** type America (American material)  
**1414** type Italy (local material)
- mounting: with aluminium locking flanges in aluminium art. 1808 (see at page 49)



art. 1404 AO



art. 1404 AO



art. 1404 big wheel AO

## STANDARD DIMENSIONS

external Ø	internal bore
110 mm.	25-30 mm.
125 mm.	50 mm.
175 mm.	65 mm.
200 mm.	76-80 mm.
250 mm.	115 mm.
300 mm.	150 mm.
350 mm.	200 mm.
400 mm.	250 mm.
450 mm.	300 mm.

## SOME APPLICATIONS FOR RODIFLEX FLAP WHEELS

<b>Aluminium profiles</b>	for satin finishing of sections for window frames and parts of buildings
<b>Various metals</b>	for satin finishing of stainless steel and non-ferrous metals, for cleaning up oxidised parts
<b>Printed circuits</b>	on plastic sheets covered with a very thin coating of electrolytic copper for the manufacture of printed circuits, RODIFLEX will polish the copper without removing it; particularly useful to remove burrs.
<b>Rubber</b>	after stamping, the surface to be glued can be prepared with RODIFLEX in the form of rollers
<b>Wooden panels and frames</b>	for sanding the base varnish and plain wood; for finishing sections of complicated shapes
<b>Other uses</b>	for tanneries, marble, silverware, goldsmiths, ceramics

# TAMPICO BRUSHES

The vegetable fibre "Tampico" used is of mexican origin, of the highest grade.

The main features of these brushes are:

- the extreme flexibility
- the high softness

which allow to polish complicated shapes and to achieve a particular semi-bright finish, usually known as "Tampico finish".

These brushes are often subjected to impregnation to improve the lifetime and increase the adhesion of the abrasive compound (see details at page 22).

## TYPES OF BUFFS AND BRUSHES

### A) WITH SMALL BORE, FOR MANUAL MACHINES

- **external Ø:** 80-300 mm.
- **internal bore:** 10-25 mm.
- **article reference:** **1501**

We can realize special dimensions at request.

### B) WITH METAL SEAM, FOR AUTOMATIC MACHINES

- **external Ø:** 200-500 mm.
- **internal bore:** 55-230 mm.
- **article reference:** **1502**

We can realize special dimensions at request.



Tampico buffs and brushes



art. 1501



art. 1501 with impregnation TPL



art. 1502

## C) BRUSHES AND CYLINDERS

These items are made with the tampico fibres fitted around a wooden or plastic core of suitable shape (for the brushes) or around a wooden or plastic tube (for the cylinders). They can be subjected to impregnation (details at page 22).

1) art. 1503 "flat head" brush  
- dimensions at request

2) art. 1504 "round head" brush  
- dimensions at request

3) art. 1505 type cylinder  
- **external Ø:** 80-250 mm.  
- **internal bore:** at request  
- **thickness:** 50-200 mm.

- **applications:** on automatic machines, for polishing the internal surfaces (bottoms and sides) of trays, saucepans, basins, sinks in stainless steel.



Brushes and Cylinders

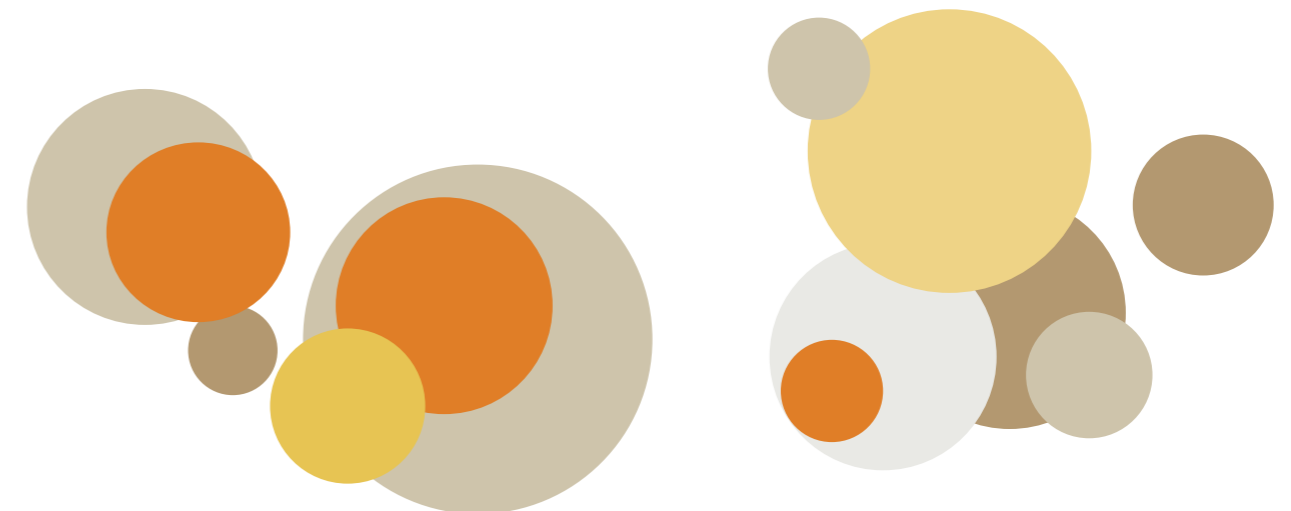



# PLAITED SISAL BRUSHES

The main features of the plaited sisal brushes are the extreme flexibility and the softness, which make possible to polish complicated shapes and to obtain a uniform semi-bright finish. They are used mostly impregnated to increase the lifetime (details at page 22).

## PLAITED SISAL BUFFS

- |                |                        |                        |   |
|----------------|------------------------|------------------------|---|
| - external Ø:  | - internal bore:       | - articles references: | - applications:   |
| A) 250-500 mm. | 50-230 mm.             | <b>1161</b>            | to polish and bright finish shaped pieces like drip flap of sinks, cooking tops of stoves, trays specific for cutlery |
| B) 80-230 mm.  | 19/6, 20, 24/6, 25 mm. | <b>1315</b>            |   |



art. 1161



Trays polishing



Plaited sisal brushes

## PLAITED SISAL BRUSHES

- |                        |  |
|------------------------|--|
| - external Ø:          | at request (from 80 to 230 mm.)                          |
| - internal bore:       | 19/6, 20, 24/6, 25 mm.                                   |
| - thickness:           | from 15 to 50 mm.  |
| - articles references: | <b>1348</b> type "straight"<br><b>1349</b> type "convex" |
| - applications:        | to polish cutlery (spoons and forks)                     |

## PLAITED SISAL CYLINDERS

These cylinders are made with plaited sisal fitted around a metal, wooden, plastic tube. To increase the life and hardness, these items are subjected to impregnation (details at page 22).

- |                        |  |
|------------------------|--|
| - external Ø:          | 100-150-200 mm.  |
| - internal bore:       | 40, 50, 60 mm.   |
| - thickness:           | from 50 to 300 mm.   |
| - articles references: | <b>1162</b>  |
| - applications:        | for internal work polish of surfaces (bottoms and sides) of pots, basins, sinks in stainless steel, on automatic polishing machines. |



art. 1162

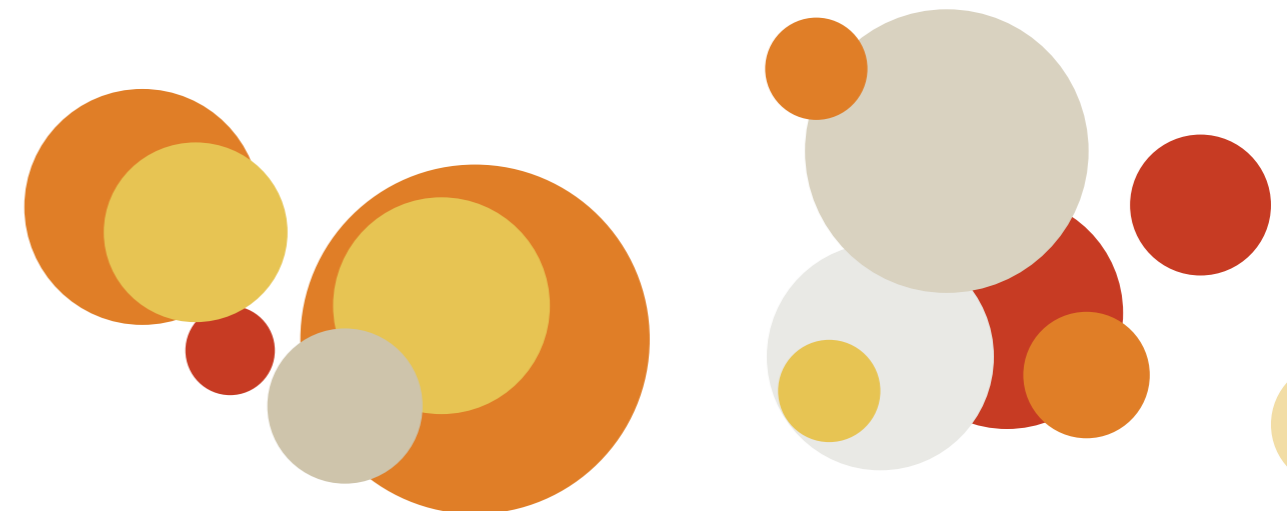

# SISAL AND SISAL + COTTON BUFFS

The sisal cloth come from the agave plant, which grows in South Africa and South America. Sisal is a strong fibre very suitable for the polishing of metal surfaces.

The choice of first quality fibres for polishing and semi-bright finishing is the guarantee for effective and lasting tools.

The mops made up of sisal cloth are particularly suitable for polishing operations that follow the grinding process (with abrasive cloth items) and are used with aggressive cutting compounds.

The sisal buffs are generally subjected to impregnations (details at page 22) to achieve a better cohesion of the fibres, better consistency and longer life.

The presence of the cotton mixed to sisal cloth (the cotton cloth is lined on sisal cloth through various stitches to strengthen), reduces the unravelling of the sisal, increases its life, improves the retention of the compound and gives a particular semi-bright finish.

Also the sisal+cotton buffs are generally impregnated (details at page 22) to obtain a better structure of the fibres, higher consistency and longer life.



## VENTILATED BUFFS



art. 1106 4 layers



art. 1106 4 layers with impregnation type GREY



art. 1106 4 layers with impregnation type GREEN

STANDARD DIMENSIONS	
external Ø	internal bore
250 mm.	55-80 mm.
300 mm.	55-80-110 mm.
350 mm.	80-110-130 mm.
400 mm.	80-130-150-180 mm.
450-500 mm.	130-150-180 mm.
600 mm.	180-230 mm.

We can realize special dimensions at request.

- **external Ø:** 250-600 mm.
- **internal bore:** 55-230 mm.
- **layers:** 2, 4, 6, 8
- **cloth types:**
  - only sisal: for shaped aluminium profiles; achieve a semi-bright finish.
  - sisal+cotton: for all metals; achieve a semi-bright finish; thanks to the presence of cotton cloth the buff has longer life.
  - They can be impregnated to increase life and cutting power (details at page 22).
  - impregnated sisal+cotton.
  - impregnated sisal+treated cotton.
- **assembly:**
  - PV = light ventilation
  - NV = normal ventilation
  - MV = heavy ventilation
- **articles reference:**
  - 1106 only sisal, 4-6-8 layers
  - 1101 sisal+cotton, 2 layers
  - 1102 sisal+cotton, 4 layers
  - 1105 sisal+treated cotton GOLDEN GG, 4 layers
  - 1107 TP impregnated sisal+treated cotton GOLDEN GG, 4 layers
- **applications:** for polishing operations on aluminium profiles, aluminium and stainless steel sheets, pipes and tubes, shaped pieces, etc.

Various combinations with abrasive compounds can achieve different rate of bright and mirror finishes.



art. 1102  
with impregnation type YELLOW



art. 1102  
with impregnation type GREEN



art. 1102  
with impregnation type GREY



art. 1102  
with impregnation type BLU



art. 1102  
with impregnation type LIGHT BLUE



art. 1102



Polishing of aluminium profiles

## BUFFS FOR CUTLERY

- external Ø: 80-220 mm.
- internal bore: 19/6, 20, 24/6, 25 mm.
- layers: 2-4
- cloth types: sisal, sisal+cotton
- articles references: **1314** only sisal, 2 layers  
**1345** only sisal, 4 layers  
**1313** sisal+cotton, 2 layers  
**1344** sisal+cotton, 4 layers
- applications: for polishing and bright finishing cutlery (spoons, forks, knives, etc.)

All the above buffs are generally subjected to impregnations (details at page 22).

To know the full range of articles for polishing and bright finishing of cutlery, see also:

- simple sections cotton buffs, ventilated cotton buffs, stitched cotton buffs pages 24/25/27
- plaited sisal buffs page 38
- plaited sisal brushes page 38



Polishing of sinks with ventilated buffs

Sisal+cotton buffs for cutlery



# PLEATED SISAL BUFFS

The pleated sisal buffs are used almost exclusively on automatic machines for polishing and bright finishing of shaped pieces.

Each single layer is folded in a "Z" shape (pleated) and then arranged around the centre in different ways:

- standard (ST) = for buffs with metal seam (ring), result: rigid buffs
- spiral (SP) = for big diameter buffs, result: more flexible buffs

## A) PLEATED BUFFS WITH METAL SEAM

- pleat: STANDARD (ST)
- external Ø: 250-500 mm.
- internal bore: 50-230 mm.
- standard layers: 1x2
- cloth types: only sisal: for semi-bright finish of aluminium profiles  
sisal+cotton: for heavy roughing work, thanks to the high removal rate.

These buffs can be impregnated (details at page 22), for longer life and higher cutting power.

- articles reference: **1121** only sisal, produces a semi-bright finish  
**1120** sisal+cotton, made up with sisal and lined with cotton, which increases consistency, hardness and abrasiveness.
- applications: for polishing of shaped aluminium profiles.



art. 1120

## B) SPIRAL PLEATED BIG DIAMETER BUFFS FOR ROBOT

- pleat: SPIRAL (SP)
- external Ø: 700-960-1600 mm. with cardboard centre at request
- internal bore: at request
- layers: 1x2, 1x3
- cloth types: TP impregnated sisal + treated cotton GOLDEN GG

- article reference: **1118**
- applications: for robotics heavy roughing work on small shaped pieces of all metals. These buffs have the advantage to combine the long lifetime (thanks to the impregnated sisal and treated cotton cloth) with the complete respect for the polishing machine parts (in particular for the clamping fixtures).

art. 1118 detail



art. 1118 ø 1600 mm.

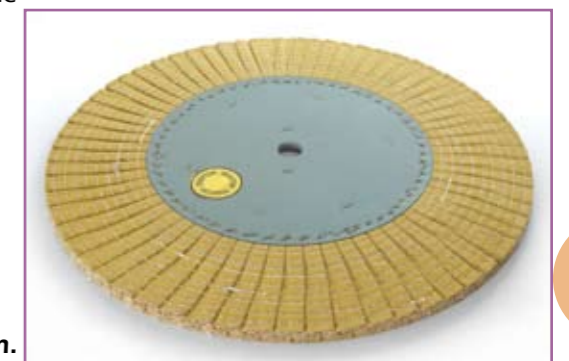

art. 1118 ø 960 mm.

# STITCHED BUFFS



art. 1166 only sisal



art. 1157 sisal + cotton



art. 1153 NS (normal thickness)



art. 1153 NS with impregnation type BLUE



art. 1153 AS (high thickness) with impregnation type GREY



art. 1153 NS with impregnation type GREEN



art. 1153 NS with impregnation type YELLOW



art. 1153 NS and AS



Polishing of cookware

## A) IN SEGMENTS

- **external Ø:** 200-600 mm.
- **internal bore:** 10-130 mm.
- **thickness:** 8-16 mm.
- **stitchings:** in spiral form with average width of 5-20 mm. (standard stitchings 5 mm.)
- **cloth types:** only sisal  
sisal+cotton  
These buffs can be subjected to impregnations (details at page 22), mainly when they are used on automatic polishing machines.
- **assembly:** sisal cloth is cutted in segments, i.e. in triangles with the fibres arranged at 45° to reduce fraying to a minimum and to ensure uniform wearing.
- **article reference:** **1166** only sisal  
**1157** sisal+cotton
- **applications:** for roughing operations on steel, chrome, iron (cookware and tableware, tubes and pipes).

## B) ALL BIAS WEAVE

The stitched buffs all bias weave (with metal seam) are suitable for automatic polishing machines and they are used for all metals, which call for heavy removal and roughing operations.

- **external Ø:** 250-600 mm.
- **internal bore:** 55-230 mm.
- **thickness:** **BS** = low thickness 10 mm.  
**NS** = normal thickness 17 mm.  
**AS** = high thickness 22-25 mm.
- **cloth type:** only sisal  
These buffs can be subjected to impregnations (details at page 22)
- **assembly:** all bias weave sisal cloth, to avoid the fraying and obtain a longer lifetime
- **article reference:** **1153** only sisal
- **applications:** for roughing operations on steel, chrome, iron: cookware and tableware, tubes and pipes; it is recommended when it is necessary to work with a single wheel, which does not open out (example: pots edges).

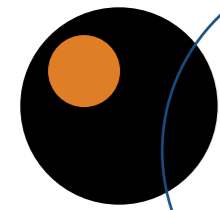

# CORRUGATED BUFFS

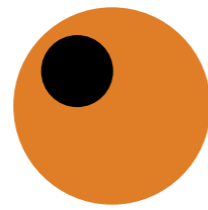

art. 1111



art. 1111 with impregnation type GREY



art. 1111 with impregnation type GREEN



art. 1111 with impregnation type YELLOW

### - standard dimensions:

- Ø 250 x 80 mm.
- Ø 300 x 80-110 mm.
- Ø 350 x 130 mm.
- Ø 400 x 130-150-180 mm.
- Ø 450 x 180 mm.
- Ø 450 x 230 mm.
- Ø 500 x 230 mm.
- Ø 550 x 230 mm.

We can realize special dimensions at request.

- **thickness:** 30 mm.

- **cloth types:** sisal+cotton

They are normally subjected to impregnations to obtain more hardness and longer lifetime (details at page 22).

- **assembly:** the cloth corrugation has been realized to get a strong aggressive effect without however overheating the work piece.

- **applications:** for roughing operations of steel, chrome, iron (pots and pans, tableware, tubes and pipes);



Polishing of cookware

# STEEL WIRE BRUSHES



The steel wire brushes are used for roughing and pre-polishing operations of stainless steel pieces: pots and pans, cutlery, sinks and basins.

Due to their special configuration, the wire brushes have high ventilation ability, so they do not suffer the overheating caused by the rotation speed. They require very greasy abrasive compounds.

- **external Ø:** 80-350 mm.
- **internal bore:** 10-80 mm.
- **thickness:** 5-13 mm. (standard 9 mm.)
- **materials** stainless steel wire: diam. 008-010-012-015-020-030-040  
Bessemer steel wire (more flexible): diam. 015-020-030-040
- **articles reference:** **1602** stainless steel wire  
**1606** Bessemer steel wire
- **applications:** for roughing operations of stainless steel

# ARTICLES IN ABRASIVE CLOTH

The abrasive cloth items are made up with coated abrasives, in the various grits, of qualified European producers, to satisfy the requirements of grinding, deburring, satin finishing on ferrous and non ferrous metals. The articles in abrasive cloth work without abrasive compounds. However, it is recommended to lubricate by TALLOW compounds (details at page 13).

**art. 1707** rolls of abrasive cloth  
length 50-100 mt. (or at request)  
width at request

**art. 1708** jointed belts of abrasive cloth  
length and width at request

**art. 1702** flap wheels of abrasive cloth

STANDARD DIMENSIONS IN MM. OF FLAP WHEELS  
ART. 1702

external ø	internal bore	thickness
165	54	30-50
200	54	30-50
250	100	30-100
300	100	30-100
350	170	30-100
400	170	30-100

**art. 1703** flap wheels of abrasive cloth with drive pin

STANDARD DIMENSIONS IN MM. OF FLAP WHEELS  
ART. 1703

external ø	internal bore	thickness
30	6	50-20
40	6	10-30
50	6	10-30
60	6	15-50
80	6	15-50



## PRESSURE

Use only a slight pressure, as the work is done by the abrasive and not by the force exerted by the operator or the machine. Excessive pressure results in rapid wear and unsatisfactory finish.

# MOUNTING ACCESSORIES FOR MOPS AND BRUSHES

For mounting mops and brushes on the polishing machine's shaft, it is necessary to use:

- **sheet metal centres:**

- **cardboard spacers:**

- **locking flanges:**

to adapt and reduce the internal bore of the mops/brushes to the shaft diameter. where buffs have a larger width on the outside circumference when compared with the width of the metal rings, cardboard spacers must be used to offset this difference in width. If this is not done, the metal rings could open. In addition, the use of the cardboard spacers avoid the buffs sliding on the shaft.

to lock the buffs and the sheet metal centres to the shaft of the machine

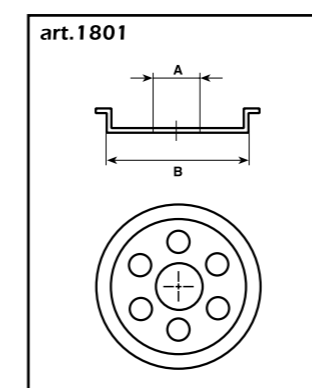

**art. 1801**  
**SHEET METAL CENTRES**  
external ø 55-230 mm.  
internal bore at request  
- re-usable -

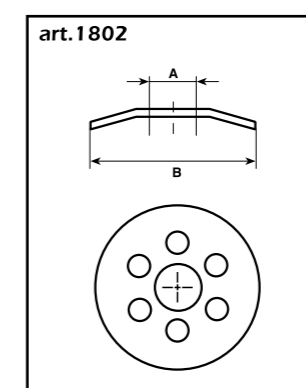

**art. 1802**  
**STEEL LOCKING FLANGES**  
external ø 90-270 mm.  
internal bore at request  
- re-usable -

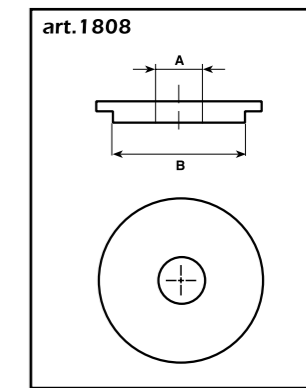

**art. 1808**  
**ALUMINIUM LOCKING FLANGES FOR FLAP WHEELS**  
external ø at request  
internal bore at request  
- re-usable -

BUFFS/MOPS INTERNAL BORE	REDUCTIONS	CARBOARD SPACERS	FLANGE (PAIRS)
	art. 1801	art. 1804 (cardboard)	art. 1802 (steel)
	external ø	external ø	external ø
55 mm.	55 mm.	90 mm.	90 mm.
80 mm.	80 mm.	120 mm.	120 mm.
110 mm.	110 mm.	150 mm.	150 mm.
130 mm.	130 mm.	170 mm.	170 mm.
150 mm.	150 mm.	200 mm.	190 mm.
180 mm.	180 mm.	220 mm.	220 mm.
230 mm.	230 mm.	280 mm.	270 mm.



Cardboard spacers

art. 1804  
**CARDBOARD SPACERS**  
 external ø 90-280 mm.  
 internal bore at request  
 - re-usable -



Reductions and flanges

art. 1820  
**FLANGES FOR BIG DIAMETER BUFFS**  
 availables for the dimensions of big diameter buffs  
 - re-usable -

**Notes:** the mounting accessories can be re-used: when buffs or brushes are consumed, the reductions, the spacers and flanges can be mounted on new sets. It is also possible to produce buffs and brushes with inside reductions made to measure: this feature involves a huge increase of buffs and brushes prices.

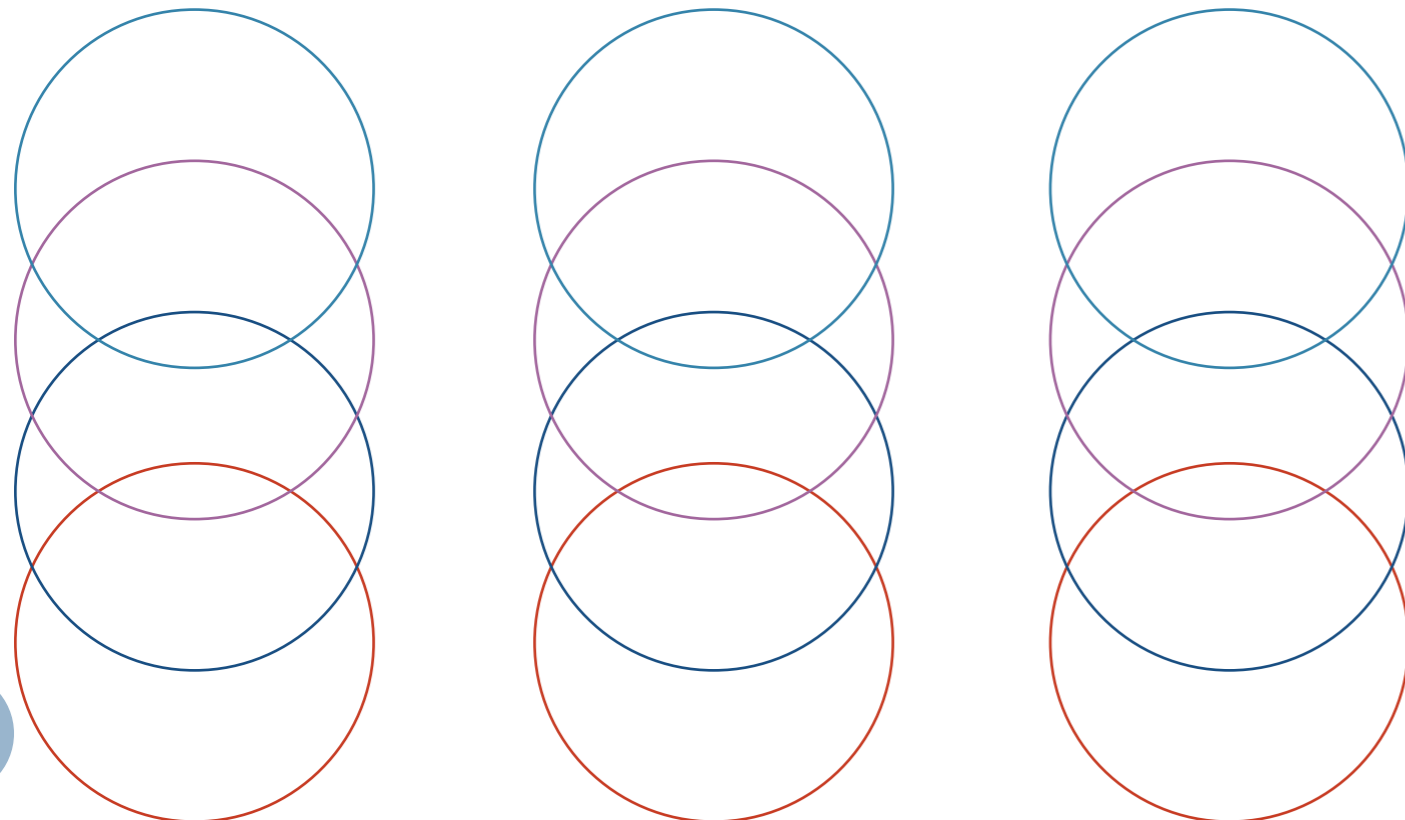

## WORKING CYCLE FOR STAINLESS STEEL POTS AND LIDS

**Introduction:** according to the number of polishing heads and units, to the operators and workers experience, to the required finishing rate, it is possible to use various combinations of polishing articles; here below some examples.

### CYCLE FOR EXTERNAL PARTS OF STAINLESS STEEL COOKWARE

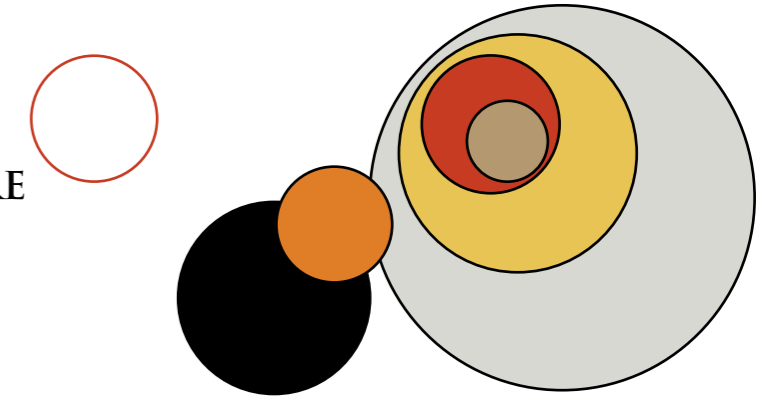

### Example with a 10 polishing units Sillem machine

HEAD	CYCLE	ITEM	CATALOGUE	LIQUID COMPOUNDS
1	 polishing of walls	art. 1702 flap wheel of abrasive cloth	page 48	art. 3724 solid TALLOW or art. 3741 liquid TALLOW
2	 polishing of bottom-wall bond	art. 1602 stainless steel wire brush	page 47	art. 3536 type AP/58 TC art. 3521 type AP/51
3	 polishing of under-edge and bottom-wall bond	UP art. 1153 stitched sisal buff all bias weave, impregnation type: YELLOW, GREY, GREEN, BLUE  DOWN art. 1111 corrugated sisal+cotton buff with impregnation type: GREY, GREEN	page 45  page 46	art. 3536 type AP/58 TC art. 3521 type AP/51 art. 3539 type AP/31 C

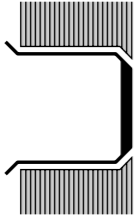
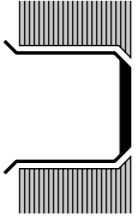
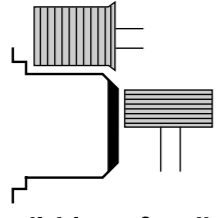
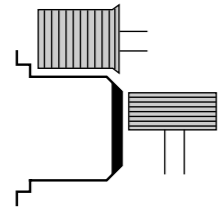
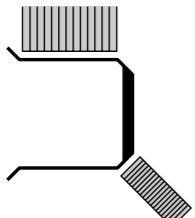
HEAD	CYCLE	ITEM	CATALOGUE	LIQUID COMPOUNDS
4	 polishing of walls	<b>UP art. 1102</b> ventilated sisal+cotton buff 4 layers with impregnation type: BLUE <b>DOWN art. 1111</b> corrugated sisal+cotton buff with impregnation type: GREY, GREEN, BLUE	page 42 page 46	art. 3536 type AP/58 TC art. 3521 type AP/51 art. 3539 type AP/31 C
5	 polishing of walls	<b>UP art. 1102</b> ventilated sisal+cotton buff 4 layers with impregnation type: BLUE or <b>art. 2045</b> corrugated buff treated cotton GOLDEN GG <b>DOWN art. 1102</b> ventilated sisal+cotton buff 4 layers with impregnation type: BLUE or <b>art. 2044</b> corrugated buff treated cotton ROYAL BLU	page 42 page 30 page 42 page 30	art. 3536 type AP/58 TC  art. 3521 type AP/51
6	 polishing of walls polishing of bottom	<b>art. 1102</b> ventilated sisal+cotton buff 4 layers with impregnation type: BLUE	page 42	art. 3539 type AP/31 C
7	 polishing of walls polishing of bottom	<b>UP art. 2004</b> ventilated buff treated cotton ROYAL BLU <b>DOWN art. 1002</b> ventilated buff cotton MA	page 26	art. 3533 type LUX ROSA art. 3550 type SILVER LUX/2 art. 3551 type SILVER LUX/EC art. 3564 type SILVER LUX/4 art. 3511 type SILVER LUX/11
8	 polishing of walls polishing of bottom-wall bond	<b>art. 2004</b> ventilated buff treated cotton ROYAL BLU	page 26	art. 3536 type AP/58 TC art. 3521 type AP/51 art. 3539 type AP/31 C

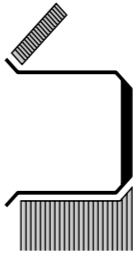
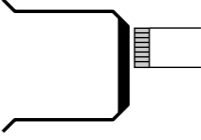
HEAD	CYCLE	ITEM	CATALOGUE	LIQUID COMPOUNDS
9	 polishing of under-edge polishing of walls	<b>art. 1002</b> ventilated buff cotton MA	page 26	art. 3533 type LUX ROSA art. 3550 type SILVER LUX/2 art. 3551 type SILVER LUX/EC art. 3564 type SILVER LUX/4 art. 3511 type SILVER LUX/11
10	 satin finishing of bottom	<b>art. 1707</b> roll of abrasive cloth to satin finish the bottom of the pot	page 48	

CYCLE FOR INTERNAL PARTS OF STAINLESS STEEL COOKWARE

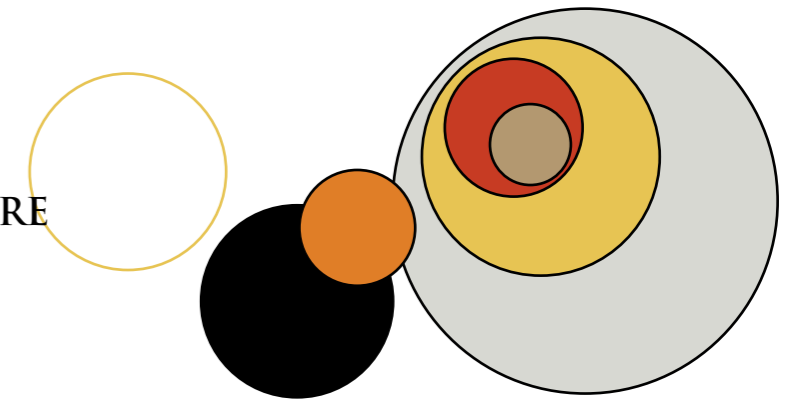

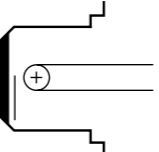
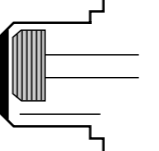
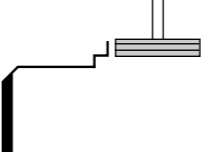
HEAD	CYCLE	ITEM	CATALOGUE	LIQUID COMPOUNDS
1	 bottom	<b>art. 1708</b> jointed belt of abrasive cloth	page 48	
2	 walls	<b>art. 1702</b> flap wheel of abrasive cloth	page 48	art. 3724 solid TALLOW or art. 3741 liquid TALLOW
3	 edge	<b>art. 1153</b> stitched sisal buff all bias weave	page 45	art. 3536 type AP/58 TC art. 3521 type AP/51 art. 3539 type AP/31 C



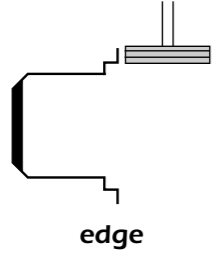
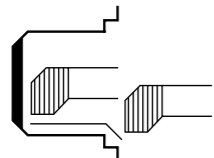
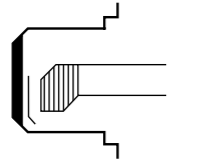
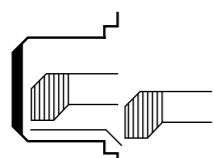

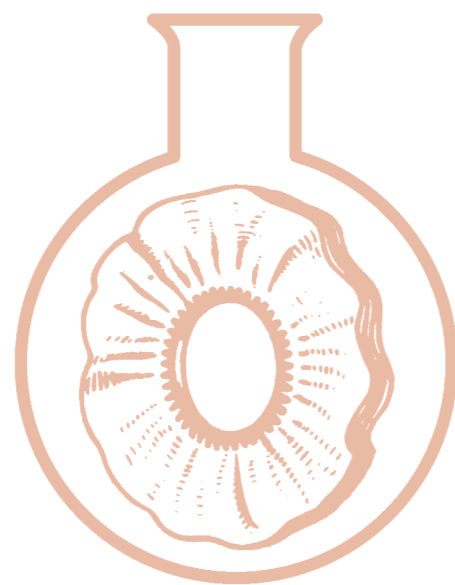

HEAD	CYCLE	ITEM	CATALOGUE	LIQUID COMPOUNDS
4	 edge	<b>art. 1002</b> ventilated buff cotton MA	page 26	art. 3533 type LUX ROSA art. 3550 type SILVER LUX/2 art. 3551 type SILVER LUX/EC art. 3564 type SILVER LUX/4 art. 3511 type SILVER LUX/11
5	 wall + internal edge	<b>art. 1707</b> roll of abrasive cloth in different grits	page 48	
	 bottom + bottom-wall bond			
	 bottom + walls + internal edge			

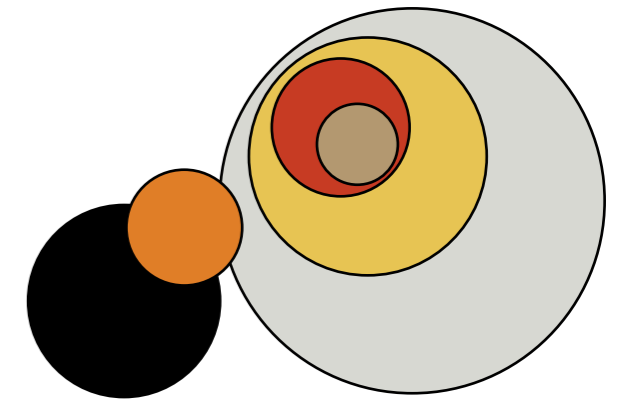

**RPH**<sup>®</sup>

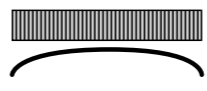
## CYCLE FOR STAINLESS STEEL LIDS

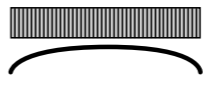

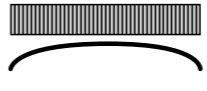
HEAD	CYCLE	ITEM	CATALOGUE	LIQUID COMPOUNDS
1	 roughing operation	<b>art. 1102</b> ventilated sisal+cotton buff 4 layers with impregnation type: BLUE	page 42	art. 3539 type AP/31 C art. 3520 type AP/20
2	 roughing operation of edges	<b>art. 1153</b> stitched sisal buff all bias weave, high thickness, with impregnation type: GREY, GREEN or	page 45	art. 3539 type AP/31 C
		<b>art. 1111</b> corrugated sisal+cotton buff with impregnation type: GREY, GREEN	page 46	
3	 bright finishing	<b>art. 2004</b> ventilated buff treated cotton ROYAL BLU	page 26	art. 3539 type AP/31 C art. 3520 type AP/20
4	 bright finishing of edges	<b>art. 2044</b> corrugated buff treated cotton ROYAL BLU or <b>art. 1033</b> corrugated buff cotton MA	page 30	art. 3550 type SILVER LUX/2
5	 bright finishing	<b>art. 1002</b> ventilated buff cotton MA	page 26	art. 3533 type LUX ROSA

## CYCLE FOR ALUMINIUM COOKWARE

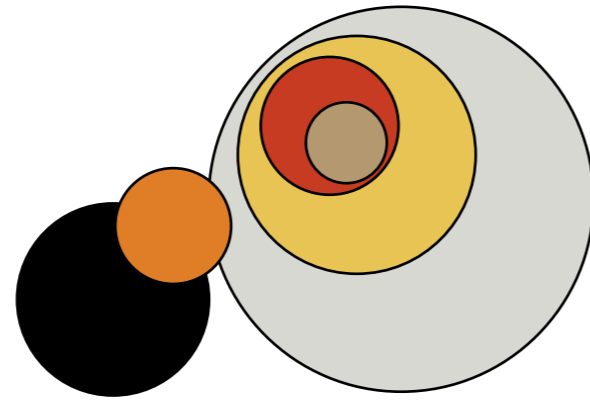

The treatment of aluminium cookware requires the use of specific tools for polishing and bright-mirror finishing.

HEAD	CYCLE	ITEM	CATALOGUE	COMPOUNDS
1	polishing operation	art. 1102 ventilated sisal+cotton buff 4 layers, with impregnation type: BLUE	page 42	LIQUID: art. 3520 type AP/20 art. 3521 type AP/51 C art. 3530 type AIR/ROSE 4 SOLID: art. 3674 type BROWN/ROBOT 2004 art. 3646 type BLU INOX/38 art. 3615 type BIANCA MILLENIUM
2	midway operation	art. 2004 ventilated buff treated cotton ROYAL BLU	page 26	LIQUID: art. 3520 type AP/20 art. 3530 type AIR/ROSE 4 SOLID: art. 3674 type BROWN/ROBOT 2004
3	bright finishing operation	art. 1002 ventilated buff cotton MA art. 1205 ventilated buff woollen cloth + cotton MA	page 26 page 31	LIQUID: art. 3550 type SILVER LUX/2 art. 3532 type LUX BLU art. 3533 type LUX ROSA SOLID: art. 3636 type AZZURRA/N art. 3645 type AZZURRA/94

## CYCLE FOR POLISHING AND BRIGHT FINISHING CUTLERY

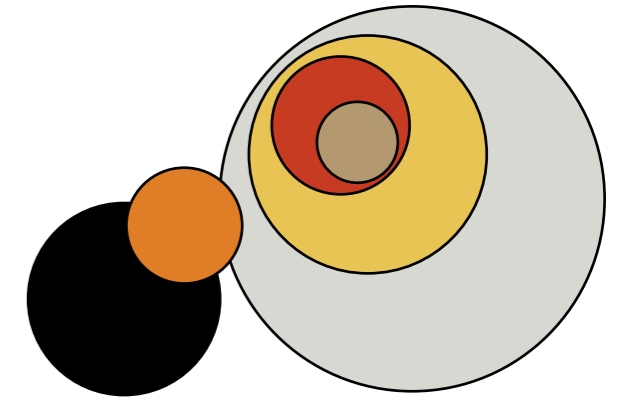
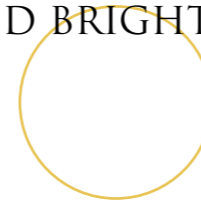

**Introduction:** according to the number of polishing heads and units, to the operators and workers experience, to the required finishing rate, it is possible to use various combinations of polishing articles; here below some examples.

### Example with a 6 polishing units Sillem machine polishing and bright finishing of cup

HEAD	ITEM	CATALOGUE	LIQUID COMPOUNDS	NOTES
1	UP art. 1606 Bessemer steel wire buffs (wire diam. 0,15) (*)  DOWN art. 1344 ventilated sisal+cotton buffs 4 layers, with impregnation type: BLUE	page 47  page 42	art. 3521 type AP/51 C art. 3539 type AP/31 C	(*) for forks it is advisable to set up the shaft of the machine only with Bessemer steel wire brushes; for spoons it is recommended to space out the brushes
2	UP art. 1606 Bessemer steel wire buffs (wire diam. 0,15)  DOWN art. 1344 ventilated sisal+cotton buffs 4 layers, with impregnation type: BLUE (**)	page 47  page 42	art. 3521 type AP/51 C art. 3539 type AP/31 C	(**) it is possible to set up the shaft of the machine with ventilated sisal+cotton buffs combined with tampico brushes
3	UP art. 1501 Tampico brushes  DOWN art. 1344 ventilated sisal+cotton buffs 4 layers, with impregnation type: BLUE	page 36  page 42	art. 3521 type AP/51 C art. 3539 type AP/31 C	
4	UP & DOWN art. 2324 ventilated buffs treated cotton ROYAL BLU, 8 layers	page 27	art. 3550 type SILVER LUX/2 art. 3511 type SILVER LUX/11	
5	UP art. 1311 ventilated buffs cotton MA, 8 layers DOWN art. 2324 ventilated buffs treated cotton ROYAL BLU, 10 layers	page 27	art. 3550 type SILVER LUX/2 art. 3511 type SILVER LUX/11	

HEAD	ITEM	CATALOGUE	LIQUID COMPOUNDS	NOTES
6	<b>UP art. 1311</b> ventilated buffs cotton MA, 8 layers  <b>DOWN art. 1311</b> ventilated buffs cotton MA, 10 layers	page 27	art. 3550 type SILVER LUX/2 art. 3511 type SILVER LUX/11	

Example with a 3 polishing units Sillem machine polishing and bright finishing of handle

1	<b>UP &amp; DOWN art. 1348</b> Plaited sisal brushes, with impregnation type: YELLOW	page 38	art. 3521 type AP/51 C art. 3539 type AP/31 C	
2	<b>UP art. 2324</b> ventilated buffs treated cotton ROYAL BLU, 8 layers  <b>DOWN art. 2324</b> ventilated buffs treated cotton ROYAL BLU, 10 layers	page 27	art. 3521 type AP/51 C art. 3539 type AP/31 C art. 3550 type SILVER LUX/2 art. 3511 type SILVER LUX/11	
3	<b>UP art. 1311</b> ventilated buffs cotton MA, 8 layers  <b>DOWN art. 1311</b> ventilated buffs cotton MA, 10 layers	page 27	art. 3550 type SILVER LUX/2 art. 3511 type SILVER LUX/11	

## CYCLE FOR STAINLESS STEEL SINKS

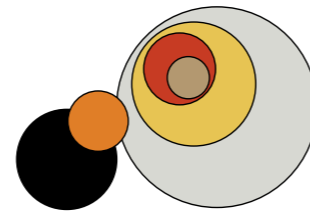

**Introduction:** according to the number of polishing heads and units, to the operators and workers experience, to the required finishing rate, it is possible to use various combinations of polishing articles; here below some examples.

HEAD	ITEM	CATALOGUE	LIQUID COMPOUNDS
1 ROUGHING AND POLISHING	<b>art. 1344</b> ventilated sisal+cotton buffs 4 layers <b>art. 1102</b> ventilated sisal+cotton buffs 4 layers <b>art. 1504</b> Tampico brushes round head	page 41-42  page 37	art. 3521 type AP/51 C
2 BRIGHT FINISHING	<b>art. 1311</b> ventilated buffs cotton MA 10 layers <b>art. 1002</b> ventilated buffs cotton MA 12 layers	page 26-27	art. 3532 type LUX BLU

## CYCLE FOR STAINLESS STEEL SHEETS WITH BENCH MACHINES

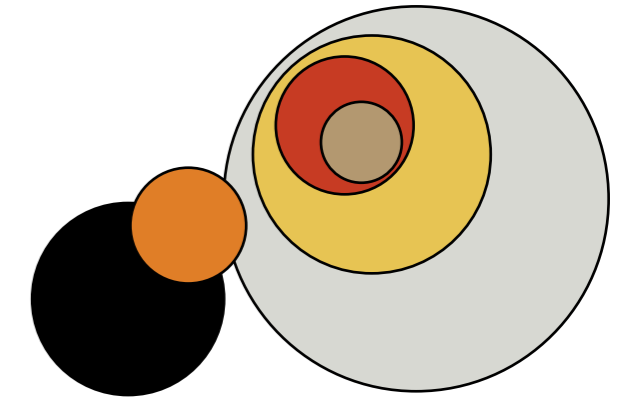

### First operation - roughing and polishing

HEAD	ITEM	CATALOGUE	LIQUID COMPOUNDS	SOLID COMPOUNDS
1	<b>art. 1102</b> ventilated sisal+cotton buff 4 layers, with impregnation type: BLUE	page 42	art. 3539 AP/31 C art. 3521 AP/51 C	art. 3646 BLU INOX/38 art. 3636 AZZURRA/N

### Second operation - bright and mirror finishing

HEAD	ITEM	CATALOGUE	LIQUID COMPOUNDS	SOLID COMPOUNDS
2	<b>art. 1002</b> ventilated buff cotton MA <b>art. 1004</b> ventilated buff cotton MC	page 26	art. 3550 SILVER LUX/2	art. 3645 AZZURRA/94

### NOTES

These buffs can be used both on manual and automatic polishing machines, to achieve the bright finish of flat and shaped stainless steel surfaces. They are suitable also for aluminium, brass and alloys.

## IN SHORT

It is clear that the final successful result of the polishing process is determined by a number of factors, such as:

- type of mop
- type of abrasive compound
- type of polishing machine
- quality of metal
- shape of the working piece
- working time
- number of passes
- feeding speed
- contact pressure
- peripheral speed, etc.

Therefore general rules valid for all conditions do not exist.

The descriptions of the mops and compounds as well as the suggestion given in this catalogue are in general terms; our technical and commercial staff are at disposal to provide necessary assistance and cooperation.

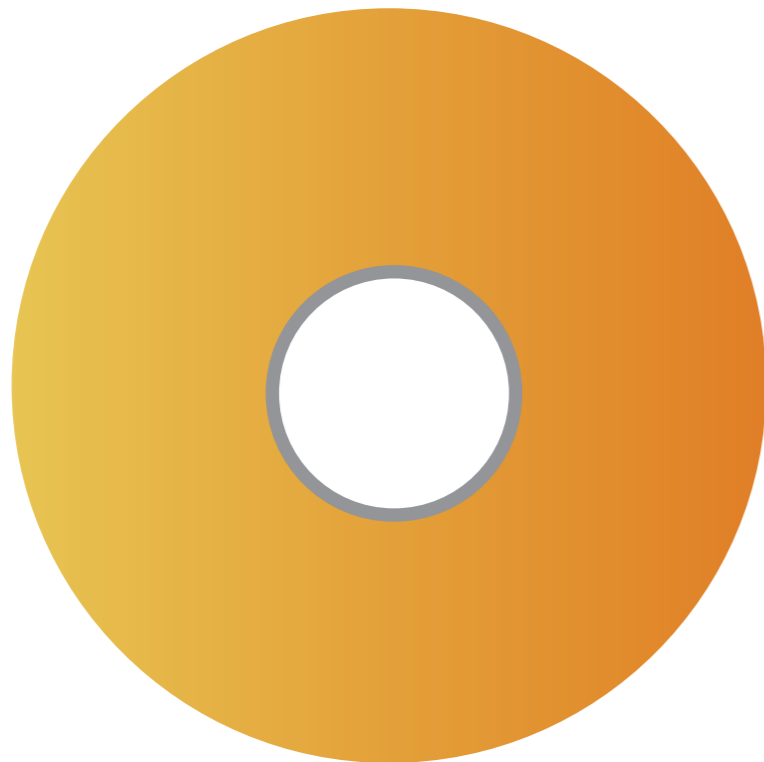

## INDEX

<b>page 3</b>	Presentation
<b>page 4</b>	History
<b>page 5</b>	Production Plant
<b>page 6</b>	The Surface Treatment of Metals
<b>page 7/12</b>	Liquid and Solid Abrasive Compounds
<b>page 13</b>	Various Compounds
<b>page 14/15</b>	Spraying and Feeding System for liquid and solid compounds
<b>page 16/17</b>	Components
<b>page 18</b>	Technical information
<b>page 19/21</b>	Bufs - Mops - Wheels for polishing and bright finishing
<b>page 22</b>	Impregnations
<b>page 23</b>	Cotton bufes
<b>page 24/25</b>	Simple sections and Stitched bufes
<b>page 26/27</b>	Ventilated bufes
<b>page 28/29</b>	Pleated bufes
<b>page 30</b>	Corrugated bufes
<b>page 31</b>	Woollen cloth bufes/Woollen cloth + Cotton bufes for Aluminium and Alloys
<b>page 32</b>	Rodiflex Bufes and Wheels
<b>page 33</b>	Simple sections and Ventilated bufes
<b>page 34</b>	Pleated bufes
<b>page 35</b>	Flap wheels
<b>page 36/37</b>	Tampico Brushes
<b>page 38/39</b>	Plaited Sisal Brushes
<b>page 40</b>	Sisal and Sisal + Cotton brushes
<b>page 41/42</b>	Ventilated bufes
<b>page 43</b>	Pleated bufes
<b>page 44/45</b>	Stitched bufes
<b>page 46</b>	Corrugated bufes
<b>page 47</b>	Steel Wire brushes
<b>page 48</b>	Articles in Abrasive Cloth
<b>page 49/50</b>	Mounting Accessories for mops and brushes
<b>page 51/59</b>	Working cycles: examples
<b>page 60</b>	Conclusion