

# 710 Magnum

Meccanismo con movimento d'apertura frontale mediante rotazione dello schienale in un unico movimento. Il passaggio della posizione divano alla posizione letto avviene senza muovere o rimuovere nessuno degli elementi di tappezzeria. Il meccanismo è dotato di cestello a baionette che permette il fissaggio dei braccioli e dello schienale al meccanismo. Questo dà la possibilità di fissare diversi modelli, a scelta, di schienali e di braccioli che si montano e si smontano separatamente dal meccanismo. Il piano dormita può essere elettrosaldato, a doghe o a doghe larghe. Il piano seduta, per tutte le versioni, è a cinghie elastiche. Particolarità della famiglia 710 Magnum è la possibilità di utilizzare un materasso di 18cm di spessore.

## ENG

Front-opening mechanism through rotation of the backrest with only one movement. The bed can be opened without removing the cover. The mechanism is equipped with a bayonet basket that allows to fix the backrests and the armrests to the mechanism. Several models of armrests and backrests can be assembled and dismantled separately from the mechanism. The bed base can be electrowelded or provided with slats or large slats. The seats of all models are provided with elastic straps. A 18cm-thick mattress can be used on models 710 Magnum.

## ESP

Mecanismo de movimiento con apertura frontal mediante rotación del respaldo en un único movimiento. El paso de la posición sofá a la posición cama tiene lugar sin mover o quitar ninguno de los elementos de la tapicería. El mecanismo está dotado con cesta a bayoneta que permite fijar los apoyabrazos y el respaldo al mecanismo. Esto da la posibilidad de crear diferentes modelos, según la elección, de respaldos y de apoyabrazos que se montan y desmontan de forma independiente a los mecanismos. El plano-cama puede ser electrosaldado, a láminas, o a láminas anchas. El plano - sofá, para todas las versiones, es en cinchas elásticas. La Peculiaridad de la familia 710 Magnum es la posibilidad de utilizar un colchón de 18 cm de espesor

## FRA

Mécanisme encastrable avec mouvement d'ouverture frontale par rotation du dossier avec un seul mouvement. Le lit peut être ouvert sans enlever la housse. Le mécanisme est pourvu d'un coffre à baïonnettes qui permet de fixer les accoudoirs et le dossier au mécanisme. Les dossiers et les accoudoirs peuvent être assemblés et désassemblés séparément. Le plan de couchage peut être électro-soudé ou pourvu de lattes ou de larges lattes. Le plan d'assise de tous les modèles est pourvu de sangles élastiques. Le modèle 710 Magnum peut être pourvu d'un matelas d'une épaisseur de 18cm.

## DEU

Mechanismen durch einfaches Drehen der Rückenlehne und mit nur einer einzigen Bewegung frontal ausziehbar. Die Verwandlung von Sofa zu Bett geschieht ohne ein Anbauteil verschieben oder entfernen zu müssen. Der Mechanismus ist mit Bajonett-Anschlüssen ausgestattet, um so Armlehnen und Rückenlehnen einfach anzubringen und sie jeweils, unabhängig der Produktfamilie des Mechanismus, befestigen und abnehmen zu können. Diese Vorrichtung ermöglicht es somit, je nach Wunsch, unterschiedliche Varianten an Rückenlehnen und Armlehnen zu montieren. Die Liegefläche gibt es elektrogeschweißt oder mit Holzfederleisten in Standard- oder breiter Ausführung. Die Sitzfläche ist für alle Versionen mit Polstergurten ausgestattet. Das Besondere an der Produktfamilie 710 Magnum ist die Möglichkeit, Matratzen mit 18cm Dicke zu benutzen.

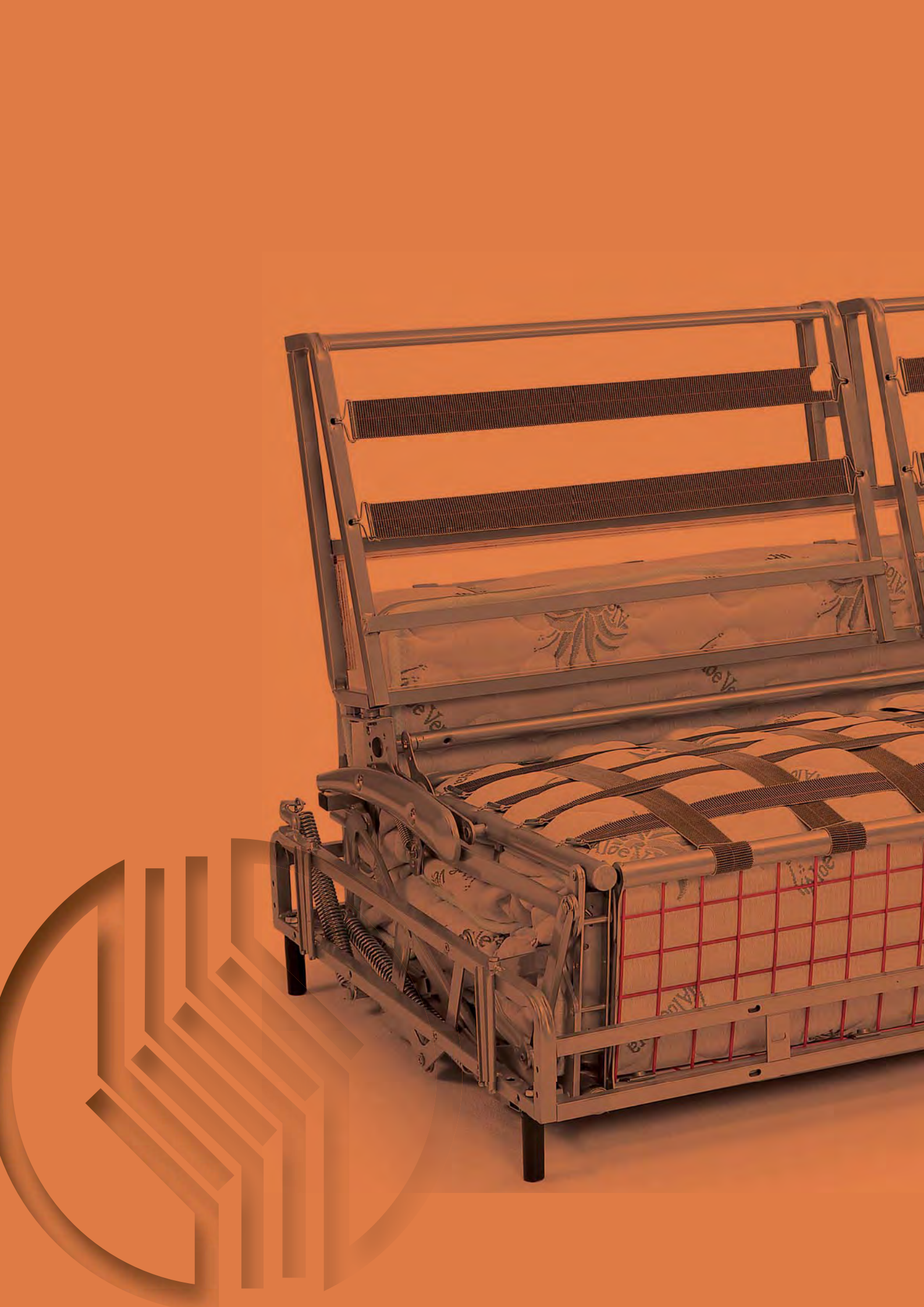

# Meccanismo





Codice/Code	Descrizione
90EL710GL182M	710 Magnum ELETTROSALDATA e cinghie 182cm G.L.
90EL710GL162M	710 Magnum ELETTROSALDATA e cinghie 162cm G.L.
90EL710GL142M	710 Magnum ELETTROSALDATA e cinghie 142cm G.L.
90EL710GL122M	710 Magnum ELETTROSALDATA e cinghie 122cm G.L.
90EL710GL092M	710 Magnum ELETTROSALDATA e cinghie 092cm G.L.

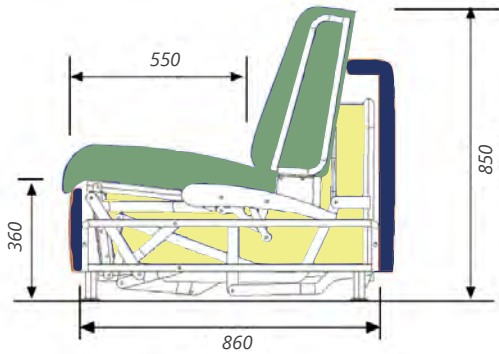
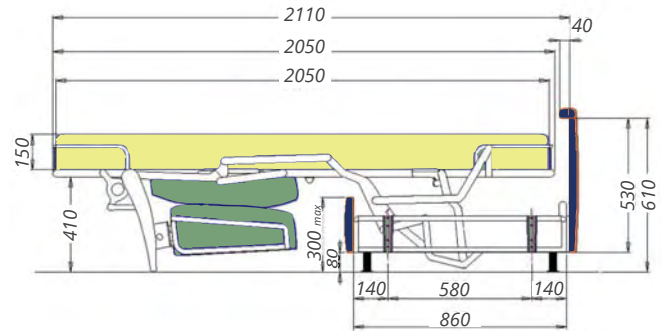
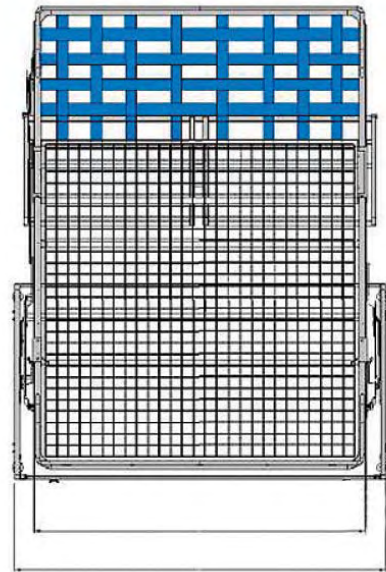
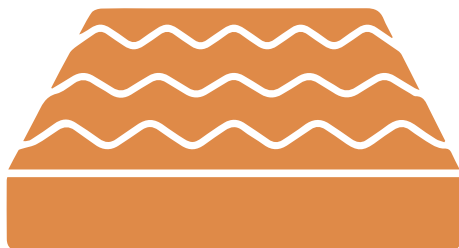

**Divano***Sofa / Sessel / Fauteil / Sofà***Versione Letto***Bed / Bett / Lit / Version cama***Larghezze***Widths / Larghezze / Largeurs*A 182 cm. B 165 cm.A 162 cm. B 145 cm.A 142 cm. B 125 cm.A 122 cm. B 105 cm.A 092 cm. B 075 cm.**Materasso***Mattress / Matratze / Matelas / Colchòn*160x200x18140x200x18120x200x18100x200x1870x200x18



Codice/Code	Descrizione
90DGS710GL182M	710 Magnum SLATS DG60 e cinghie 182cm G.L.
90DGS710GL162M	710 Magnum SLATS DG60 e cinghie 162cm G.L.
90DGS710GL142M	710 Magnum SLATS DG60 e cinghie 142cm G.L.
90DGS710GL122M	710 Magnum SLATS DG60 e cinghie 122cm G.L.
90DGS710GL092M	710 Magnum SLATS DG60 e cinghie 092cm G.L.

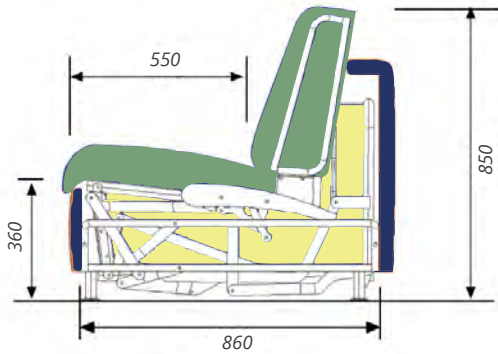
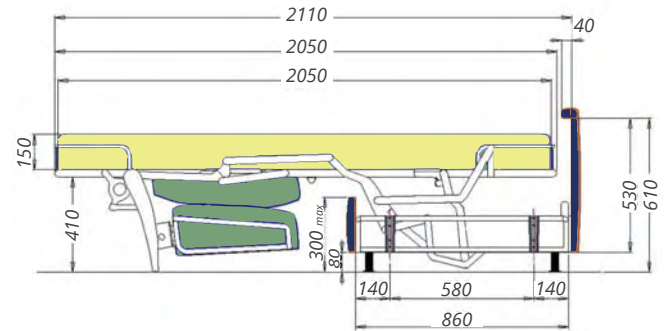

**Divano***Sofa / Sessel / Fauteil / Sofà***Versione Letto***Bed / Bett / Lit / Version cama***Larghezze***Widths / Larghezze / Largeurs***A** 182 cm. **B** 165 cm.      **A** 122 cm. **B** 105 cm.**A** 162 cm. **B** 145 cm.      **A** 092 cm. **B** 075 cm.**A** 142 cm. **B** 125 cm.**Materasso***Mattress / Matratze / Matelas / Colchòn*

160x200x18

100x200x18

140x200x18

70x200x18

120x200x18

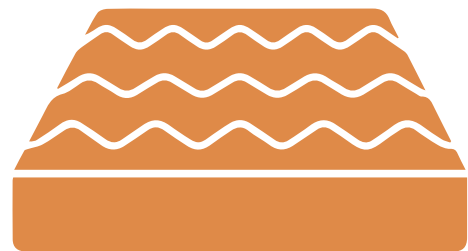
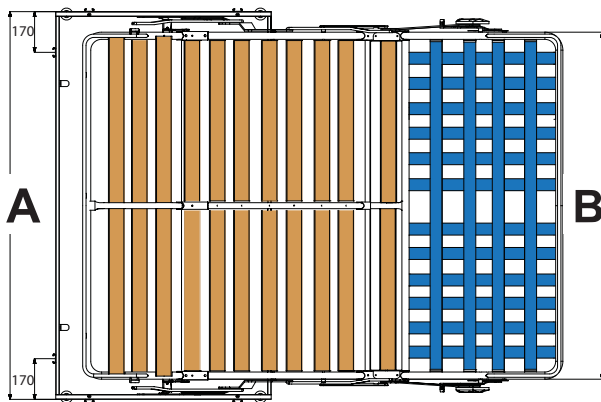
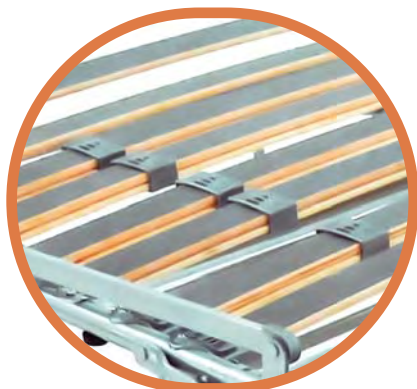
**Doghe Carbon Look e regolatori rigidità piano dormita***Carbon look slats and hardness regulators for sleeping plane*

*Piano Dormita disponibile  
con regolatori di rigidità e  
doghe CARBON LOOK*



# 710 MAGNUM

BS



Codice/Code	Descrizione
90DG710GL182M	710 Magnum BS DG150 e cinghie 182cm G.L.
90DG710GL162M	710 Magnum BS DG150 e cinghie 162cm G.L.
90DG710GL142M	710 Magnum BS DG150 e cinghie 142cm G.L.
90DG710GL122M	710 Magnum BS DG150 e cinghie 122cm G.L.
90DG710GL092M	710 Magnum BS DG150 e cinghie 092cm G.L.



**Divano**

Sofa / Sessel / Fauteil / Sofà

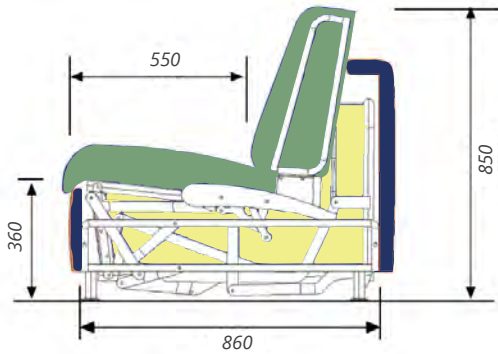
**Versione Letto**

Bed / Bett / Lit / Version cama

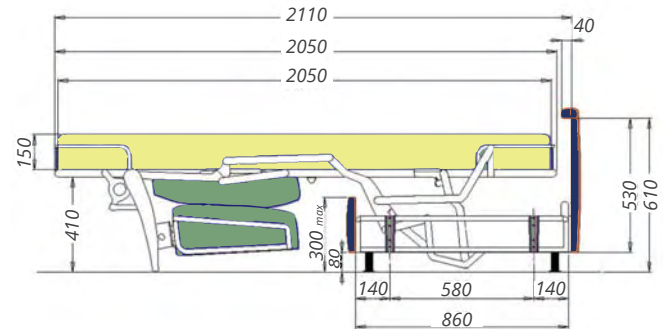
**Larghezze**

Widths / Larghezze / Largeurs

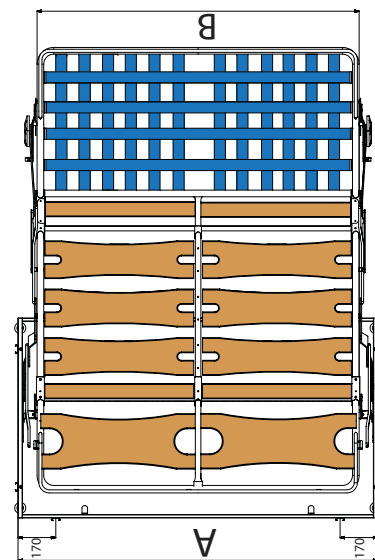
A 182 cm. B 165 cm.A 162 cm. B 145 cm.A 142 cm. B 125 cm.A 122 cm. B 105 cm.A 092 cm. B 075 cm.**Materasso**

Mattress / Matratze / Matelas / Colchòn

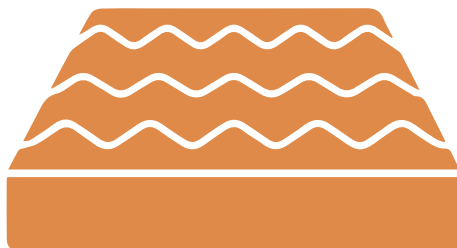
160x200x18140x200x18120x200x18100x200x1870x200x18

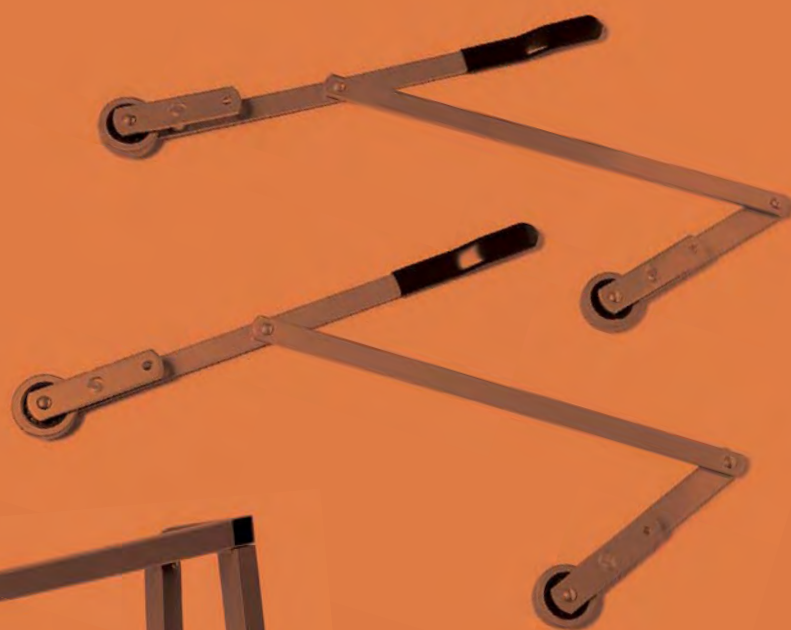

# Accessori

**SCHIENALE PORTAGUANCIALE SDOPPIATO**

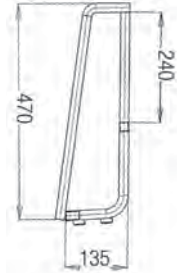

Codice/Code	Descrizione
90SCPG700GL182	SCHIENALE P.GUA.LE G.L. PER 710 182
90SCPG700GL162	SCHIENALE P.GUA.LE G.L. PER 710 162
90SCPG700GL142	SCHIENALE P.GUA.LE G.L. PER 710 142
90SCPG700GL122	SCHIENALE P.GUA.LE G.L. PER 710 122
90SCPG700GL092	SCHIENALE P.GUA.LE G.L. PER 710 092

**SCHIENALE PORTAGUANCIALE UNICO**

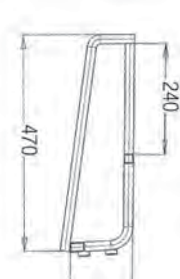

Codice/Code	Descrizione
90SCPG690GL182	SCHIENALE P.GUA.LE G.L. PER 690 182
90SCPG690GL162	SCHIENALE P.GUA.LE G.L. PER 690 162
90SCPG690GL142	SCHIENALE P.GUA.LE G.L. PER 690 142
90SCPG690GL122	SCHIENALE P.GUA.LE G.L. PER 690 122
90SCPG690GL092	SCHIENALE P.GUA.LE G.L. PER 690 092

**SCHIENALE STANDARD UNICO**

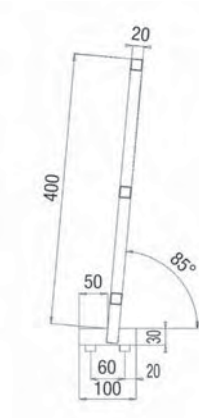

Codice/Code	Descrizione
90SCECU690GL182	SCHIENALE STD.UNICO PER 690 CM.182
90SCECU690GL162	SCHIENALE STD.UNICO PER 690 CM.162
90SCECU690GL142	SCHIENALE STD.UNICO PER 690 CM.142
90SCECU690GL122	SCHIENALE STD.UNICO PER 690 CM.122
90SCECU690GL092	SCHIENALE STD.UNICO PER 690 CM.092

## SCHIENALE TIPO N

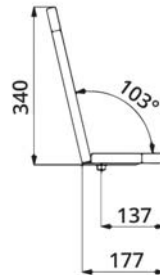

Codice/Code	Descrizione
90SCTN700GL182	SCHIENALE TIPO N PER 710 CM.182
90SCTN700GL162	SCHIENALE TIPO N PER 710 CM.162
90SCTN700GL142	SCHIENALE TIPO N PER 710 CM.142
90SCTN700GL122	SCHIENALE TIPO N PER 710 CM.122
90SCTN700GL092	SCHIENALE TIPO N PER 710 CM.092

## SCHIENALE RELAX 4

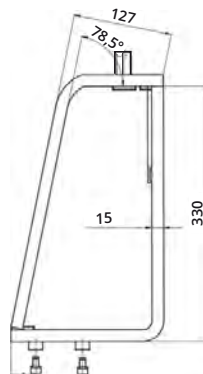

Codice/Code	Descrizione
90SCRE3692182DVRD	SCHIENALE RELAX 4 x 692 CM.182
90SCRE3692162DVRD	SCHIENALE RELAX 4 x 692 CM.162

## SCHIENALE FRONTALE

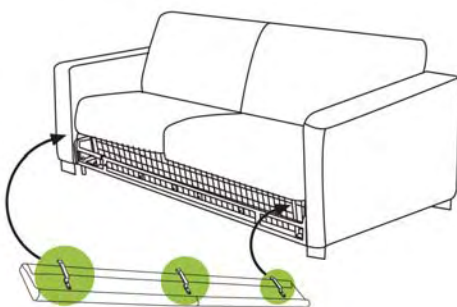
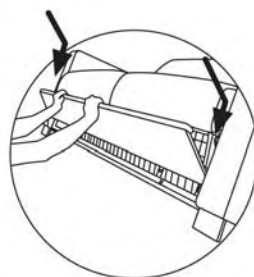

Codice/Code	Descrizione
90STANT700	STAFFE REGGI FRONTALE PER S710

### LIFT UP



Codice/Code	Descrizione
90EL710SETLIFTUP	SET LIFT UP PER 710

### PIEDINO IN PLASTICA H8



Codice/Code	Descrizione
09PPT25X80H30	PIEDINO IN PLASTICA CM 8 FILETTO H 30
09MDANZM10	DADO ESAG. NORMALE ZINC.

### AGGANCIO DP.BAIONETTA



Codice/Code	Descrizione
90AGGPEN	AGGANCIO DP. BAION.PENISOLA S710

### COPPIA BAIONETTE



Codice/Code	Descrizione
90CPBAION700	COPPIA BAIONETTE PER 690/691/692/710

## STAFFA MOD "L"



Codice/Code	Descrizione
90STAF710	STAFFA A 'L' 710

## STAFFA MOD "A"



Codice/Code	Descrizione
90STASCHLEG	COPPIA STAFFE PER SCH.LEGNO MOD.A





# Divani



**710**  
**MAGNUM**

**DIVANI**

*Sofa. Sessel. Fauteuil. Sofà.*



